



HARTNER

Precision Cutting Tools

TS-DRILLS

VOLLHARTMETALL-HOCHLEISTUNGSBOHRER

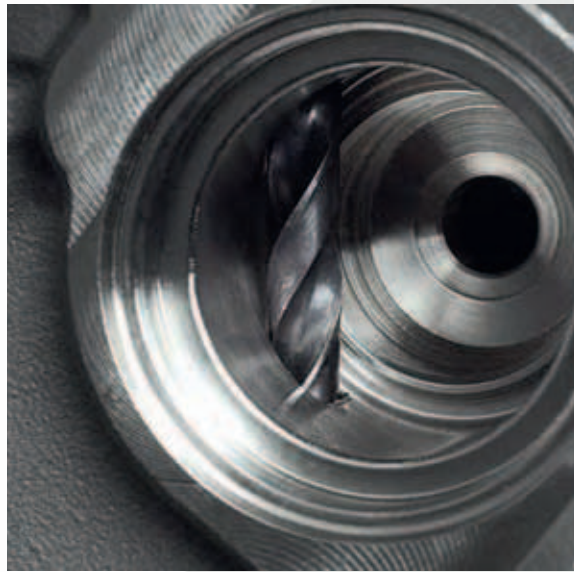

+ für jedes Material die passende Lösung

ISO-Codes

P	Stahl, hochlegierter Stahl
M	Rostfreier Stahl
K	Grauguss, Sphäroguss und Temperguss
N	Aluminium und andere Nichteisenmetalle
S	Sonder-, Super- und Titanlegierungen
H	Gehärteter Stahl und Hartguss

Piktogramme

Schneidstoff

VHM

Vollhartmetall

Oberfläche



AITIN AITIN nano blank FIRE TiAlN TiAlSiN

Typ



Bearbeitungstiefe



Norm



nach DIN nach Hartner Standard

Spitzenwinkel

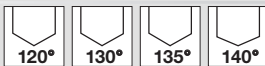

Ø-Toleranz



Schneidrichtung



rechts

Schaftform



nach DIN 6535 zylindrisch

Ausspitzung



Innenkühlung



mit Innenkühlung



ohne Innenkühlung





TS 100 U

- ▼ STAHL UND HOCHLEGIERTER STAHL, UNIVERSELLE ANWENDUNG

P	•
M	○
K	•
N	○
S	○
H	○

TS 100 U



TS 100 INOX

- ▼ ROST-, SÄURE- UND HITZEBESTÄNDIGE STÄHLE, TITAN UND TITANLEGIERUNGEN, SONDERLEGIERUNGEN

P	○
M	•
K	•
N	○
S	○
H	○

TS 100 INOX



TS 100 R | TS 150 GG

- ▼ GRAU-, TEMPER- UND SPHÄROGUSS, GGV/ADI/CDI

P	○
M	○
K	•
N	○
S	○
H	○

TS 100 R | TS 150 GG



TS 100 ALU | TS 150 GG

- ▼ ALUMINIUM-, KUPFER-, MESSING- UND BRONZELEGIERUNGEN, KUNSTSTOFFE

P	○
M	○
K	•
N	•
S	○
H	○

TS 100 ALU | TS 150 GG



TS 100 H

- ▼ LEGIERTE UND UNLEGIERTE HOCHFESTE STÄHLE, GEHÄRTETE STÄHLE, SONDER- UND TITANLEGIERUNGEN

P	•
M	○
K	•
N	○
S	•
H	○

TS 100 H



VHM-KLEINSTBOHRER

- ▼ ALLGEMEINE STAHLBEARBEITUNG BIS $\sim 1200 \text{ N/mm}^2$, UNIVERSELLE ANWENDUNG

P	•
M	•
K	•
N	○
S	○
H	○

VHM-Kleinstbohrer

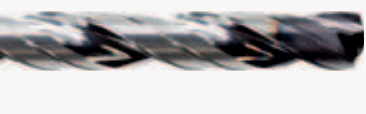

TS 100 T

- ▼ ALLGEMEINE STAHLBEARBEITUNG BIS $\sim 1200 \text{ N/mm}^2$, UNIVERSELLE ANWENDUNG

P	•
M	•
K	•
N	○
S	○
H	○

TS 100 T



EINSATZEMPFEHLUNGEN



Einsatzempfehlungen

P	M	K	N	S	H	Norm	Innenkühlung	Schneidstoff	Oberfläche	Schneidrichtung	Schaftform	Bohrtiefe	d1/mm	Artikel-Nr.	Progr. Seite
---	---	---	---	---	---	------	--------------	--------------	------------	-----------------	------------	-----------	-------	-------------	--------------

TS 100 U

	•	○	•	○	○	DIN 6537K	ohne IK	VHM	F	rechts	HA	3xD	3,000 - 20,000	89413	10
	•	○	•	○	○	DIN 6537K	ohne IK	VHM	F	rechts	HE	3xD	3,000 - 20,000	89402	10
	•	○	•	○	○	DIN 6537L	ohne IK	VHM	F	rechts	HA	5xD	3,000 - 20,000	89414	12
	•	○	•	○	○	DIN 6537L	ohne IK	VHM	F	rechts	HE	5xD	3,000 - 20,000	89417	12
	•	○	•	○	○	DIN 6537K	mit IK	VHM	F	rechts	HA	3xD	3,000 - 20,000	89410	14
	•	○	•	○	○	DIN 6537K	mit IK	VHM	F	rechts	HE	3xD	3,000 - 20,000	89415	14
	•	○	•	○	○	DIN 6537L	mit IK	VHM	F	rechts	HA	5xD	3,000 - 20,000	89411	16
	•	○	•	○	○	DIN 6537L	mit IK	VHM	F	rechts	HE	5xD	3,000 - 20,000	89408	16
	•	○	•	○	○	Werksnorm	mit IK	VHM	F	rechts	HA	7xD	3,000 - 20,000	89412	18
	•	○	•	○	○	Werksnorm	mit IK	VHM	F	rechts	HE	7xD	3,000 - 20,000	89416	18
	•	○	•	○	○	Werksnorm	mit IK	VHM	F	rechts	HA	12xD	3,000 - 20,000	89418	20

TS 100 INOX

	○	•	○	○	○	DIN 6537K	mit IK	VHM	a	rechts	HA	3xD	3,000 - 20,000	89450	24
	○	•	○	○	○	DIN 6537K	mit IK	VHM	a	rechts	HE	3xD	3,000 - 20,000	89550	24

P	M	K	N	S	H	Norm	Innenkühlung	Schneidstoff	Oberfläche	Schneidrichtung	Schaftform	Bohrtiefe	d1/mm	Artikel-Nr.	Progr. Seite
---	---	---	---	---	---	------	--------------	--------------	------------	-----------------	------------	-----------	-------	-------------	--------------

TS 100 INOX



○	●			○		DIN 6537L	mit IK	VHM	ⓐ	rechts	HA	5xD	3,000 - 20,000	89451	26
---	---	--	--	---	--	-----------	--------	-----	---	--------	----	-----	----------------	-------	----



○	●			○		DIN 6537L	mit IK	VHM	ⓐ	rechts	HE	5xD	3,000 - 20,000	89551	26
---	---	--	--	---	--	-----------	--------	-----	---	--------	----	-----	----------------	-------	----

TS 100 R | TS 150 GG



	●					DIN 6537L	mit IK	VHM	ⓑ	rechts	HA	5xD	3,000 - 20,000	89420	32
--	---	--	--	--	--	-----------	--------	-----	---	--------	----	-----	----------------	-------	----



	●					Werksnorm	mit IK	VHM	ⓑ	rechts	HA	7xD	4,000 - 20,000	89421	34
--	---	--	--	--	--	-----------	--------	-----	---	--------	----	-----	----------------	-------	----



	●	○				Werksnorm	mit IK	VHM	○	rechts	HA	4xD	3,000 - 20,000	89292	36
--	---	---	--	--	--	-----------	--------	-----	---	--------	----	-----	----------------	-------	----



	●	○				Werksnorm	mit IK	VHM	○	rechts	HA	7xD	3,000 - 20,000	89294	37
--	---	---	--	--	--	-----------	--------	-----	---	--------	----	-----	----------------	-------	----



	●	○				Werksnorm	mit IK	VHM	○	rechts	HA	10xD	3,000 - 20,000	89293	38
--	---	---	--	--	--	-----------	--------	-----	---	--------	----	------	----------------	-------	----

TS 100 ALU | TS 150 GG



		●				DIN 6537L	mit IK	VHM	○	rechts	HA	5xD	3,000 - 20,000	89560	44
--	--	---	--	--	--	-----------	--------	-----	---	--------	----	-----	----------------	-------	----



	○	●				Werksnorm	mit IK	VHM	○	rechts	HA	10xD	3,000 - 19,500	89295	46
--	---	---	--	--	--	-----------	--------	-----	---	--------	----	------	----------------	-------	----

TS 100 H





●				○		DIN 6537K	ohne IK	VHM	ⓑ	rechts	HA	3xD	3,000 - 20,000	89422	50
---	--	--	--	---	--	-----------	---------	-----	---	--------	----	-----	----------------	-------	----







●				○		DIN 6537K	mit IK	VHM	ⓑ	rechts	HA	3xD	3,000 - 20,000	89423	52
---	--	--	--	---	--	-----------	--------	-----	---	--------	----	-----	----------------	-------	----

P	M	K	N	S	H	Norm	Innenkühlung	Schneidstoff	Oberfläche	Schneidrichtung	Schaftform	Bohrtiefe	d1/mm	Artikel-Nr.	Progr. Seite
---	---	---	---	---	---	------	--------------	--------------	------------	-----------------	------------	-----------	-------	-------------	--------------



TS 100 H

	•	•	•	•	○	DIN 6537K	mit IK	VHM	Y	rechts	HE	3xD	3,000 - 20,000	89424	52
	•	•	•	•	○	DIN 6537L	mit IK	VHM	Y	rechts	HA	5xD	3,000 - 20,000	89425	54
	•	•	•	•	○	DIN 6537L	mit IK	VHM	Y	rechts	HE	5xD	3,000 - 20,000	89426	54
	•	•	•	•	○	Werksnorm	mit IK	VHM	Y	rechts	HA	7xD	3,000 - 16,000	89427	56

Kleinstbohrer

	•	•	•	○	○	Werksnorm	ohne IK	VHM	A	rechts	zyl.	4xD	0,500 - 3,000	86400	60
	•	•	•	○	○	Werksnorm	ohne IK	VHM	A	rechts	zyl.	7xD	0,500 - 3,000	86401	61
	•	•	•	○	○	Werksnorm	mit IK	VHM	A	rechts	zyl.	5xD	1,400 - 3,000	86405	62
	•	•	•	○	○	Werksnorm	mit IK	VHM	A	rechts	zyl.	8xD	1,400 - 3,000	86408	63
	•	•	•	○	○	Werksnorm	mit IK	VHM	A	rechts	zyl.	15xD	1,400 - 3,000	86412	64

TS 100 T

	•	•	•	○	○	Werksnorm	mit IK	VHM	A	rechts	HA	15xD	3,000 - 16,000	86509	68
	•	•	•	○	○	Werksnorm	mit IK	VHM	A	rechts	HA	20xD	3,000 - 16,000	86511	69
	•	•	•	○	○	Werksnorm	mit IK	VHM	A	rechts	HA	25xD	3,000 - 16,000	86512	70



P	M	K	N	S	H	Norm	Innenkühlung	Schneidstoff	Oberfläche	Schneidrichtung	Schaftform	Bohrtiefe	d1/mm	Artikel-Nr.	Progr. Seite
---	---	---	---	---	---	------	--------------	--------------	------------	-----------------	------------	-----------	-------	-------------	--------------

TS 100 T



•	•	•	○	○	Werksnorm	mit IK	VHM	A	rechts	HA	30xD	3,000 - 14,000	86513	71
---	---	---	---	---	-----------	--------	-----	---	--------	----	------	----------------	-------	----



•	•	•	○	○	Werksnorm	mit IK	VHM	A	rechts	HA	40xD	3,000 - 10,000	86514	72
---	---	---	---	---	-----------	--------	-----	---	--------	----	------	----------------	-------	----



TS 100 U

▼ VORTEILE UND EIGENSCHAFTEN

- ▼ höchste Schnittwerte und hervorragende **Bearbeitungsergebnisse** in lang- und kurzspanenden Stählen mit Festigkeiten bis ca. 1200 N/mm², Kohlenstoffstählen, Bronze, Guss und hochlegierten AISi-Legierungen
- ▼ fluchtungsgenaue Bohrungen mit **engen Durchmesser-Toleranzen** und guten Oberflächen
- ▼ präzise Zentrierung und kurze Späne dank **optimierter Schneidengeometrie** mit Zweiflächenanschliff und spezieller Ausspitzung

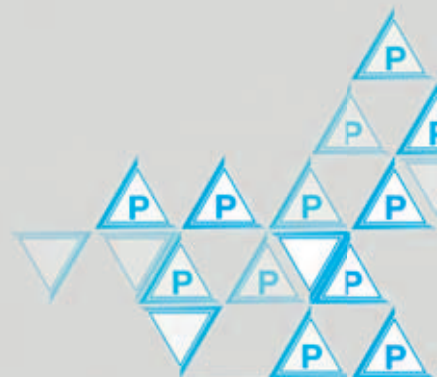

STAHL UND HOCHLEGIERTER STAHL

▼ UNIVERSELLE ANWENDUNG

spezielle Geometrie für den **universellen Einsatz** in nahezu allen Werkstoffen

Eckenschutzfase für **hohe Standzeiten** auch bei schwierigen Einsatzbedingungen

Spezialausspitzung für **exaktes Anbohren**

bei den Bohrtiefen 7xD und 12xD sichern zwei **zusätzliche Führungsfasen** die Geradheit und Rundheit der Bohrung

offenes Spannutprofil sorgt für **kurze Späne** und eine **sichere Spanabfuhr**

mehrlagige **nanoFIRE-Beschichtung** für hohe Standzeiten bei hohen Schnittwerten





TS-Drills ohne Innenkühlung

Artikel-Nr. 89413



P	M	K	N	S	H
●	○	●	○	○	○



Ausspitzung ≥ Ø 3,000 • Flächenanschliff • Hauptschneidenform gerade • optimierte Schneidengeometrie
 Bau- und Einsatzstähle • Automatenstähle, Vergütungsstähle • Stähle (legiert/unleg.) bis 1200 N/mm² • Gusswerkstoffe • Bronzen, Messing • hochlegierte AISi-Legierungen

Artikel-Nr. 89402



P	M	K	N	S	H
●	○	●	○	○	○



Ausspitzung ≥ Ø 3,000 • Flächenanschliff • Hauptschneidenform gerade • optimierte Schneidengeometrie
 Bau- und Einsatzstähle • Automatenstähle, Vergütungsstähle • Stähle (legiert/unleg.) bis 1200 N/mm² • Gusswerkstoffe • Bronzen, Messing • hochlegierte AISi-Legierungen

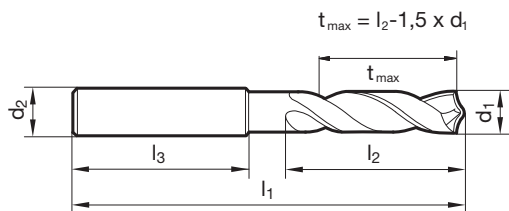

d1	inch	d2 h6	l1	l2	l3	d1	inch	d2 h6	l1	l2	l3
mm		mm	mm	mm	mm	mm		mm	mm	mm	mm
3,000		6,000	62,000	20,000	36,000	5,200		6,000	66,000	28,000	36,000
3,100		6,000	62,000	20,000	36,000	5,300		6,000	66,000	28,000	36,000
3,170	1/8	6,000	62,000	20,000	36,000	5,400		6,000	66,000	28,000	36,000
3,200		6,000	62,000	20,000	36,000	5,500		6,000	66,000	28,000	36,000
3,250		6,000	62,000	20,000	36,000	5,550		6,000	66,000	28,000	36,000
3,300		6,000	62,000	20,000	36,000	5,560	7/32	6,000	66,000	28,000	36,000
3,400		6,000	62,000	20,000	36,000	5,600		6,000	66,000	28,000	36,000
3,500		6,000	62,000	20,000	36,000	5,700		6,000	66,000	28,000	36,000
3,570	9/64	6,000	62,000	20,000	36,000	5,800		6,000	66,000	28,000	36,000
3,600		6,000	62,000	20,000	36,000	5,900		6,000	66,000	28,000	36,000
3,700		6,000	62,000	20,000	36,000	5,950	15/64	6,000	66,000	28,000	36,000
3,800		6,000	66,000	24,000	36,000	6,000		6,000	66,000	28,000	36,000
3,900		6,000	66,000	24,000	36,000	6,100		8,000	79,000	34,000	36,000
3,970	5/32	6,000	66,000	24,000	36,000	6,200		8,000	79,000	34,000	36,000
4,000		6,000	66,000	24,000	36,000	6,300		8,000	79,000	34,000	36,000
4,100		6,000	66,000	24,000	36,000	6,350	1/4	8,000	79,000	34,000	36,000
4,200		6,000	66,000	24,000	36,000	6,400		8,000	79,000	34,000	36,000
4,300		6,000	66,000	24,000	36,000	6,500		8,000	79,000	34,000	36,000
4,370	11/64	6,000	66,000	24,000	36,000	6,600		8,000	79,000	34,000	36,000
4,400		6,000	66,000	24,000	36,000	6,700		8,000	79,000	34,000	36,000
4,500		6,000	66,000	24,000	36,000	6,750	17/64	8,000	79,000	34,000	36,000
4,600		6,000	66,000	24,000	36,000	6,800		8,000	79,000	34,000	36,000
4,650		6,000	66,000	24,000	36,000	6,900		8,000	79,000	34,000	36,000
4,700		6,000	66,000	24,000	36,000	7,000		8,000	79,000	34,000	36,000
4,760	3/16	6,000	66,000	28,000	36,000	7,100		8,000	79,000	41,000	36,000
4,800		6,000	66,000	28,000	36,000	7,140	9/32	8,000	79,000	41,000	36,000
4,900		6,000	66,000	28,000	36,000	7,200		8,000	79,000	41,000	36,000
5,000		6,000	66,000	28,000	36,000	7,300		8,000	79,000	41,000	36,000
5,100		6,000	66,000	28,000	36,000	7,400		8,000	79,000	41,000	36,000
5,160	13/64	6,000	66,000	28,000	36,000	7,500		8,000	79,000	41,000	36,000



TS-Drills ohne Innenkühlung

d1 mm	inch	d2 h6 mm	l1 mm	l2 mm	l3 mm	d1 mm	inch	d2 h6 mm	l1 mm	l2 mm	l3 mm
7,540	19/64	8,000	79,000	41,000	36,000	11,400		12,000	102,000	55,000	45,000
7,600		8,000	79,000	41,000	36,000	11,500		12,000	102,000	55,000	45,000
7,700		8,000	79,000	41,000	36,000	11,600		12,000	102,000	55,000	45,000
7,800		8,000	79,000	41,000	36,000	11,700		12,000	102,000	55,000	45,000
7,900		8,000	79,000	41,000	36,000	11,800		12,000	102,000	55,000	45,000
7,940	5/16	8,000	79,000	41,000	36,000	11,900		12,000	102,000	55,000	45,000
8,000		8,000	79,000	41,000	36,000	11,910	15/32	12,000	102,000	55,000	45,000
8,100		10,000	89,000	47,000	40,000	12,000		12,000	102,000	55,000	45,000
8,200		10,000	89,000	47,000	40,000	12,100		14,000	107,000	60,000	45,000
8,300		10,000	89,000	47,000	40,000	12,200		14,000	107,000	60,000	45,000
8,330	21/64	10,000	89,000	47,000	40,000	12,300	31/64	14,000	107,000	60,000	45,000
8,400		10,000	89,000	47,000	40,000	12,400		14,000	107,000	60,000	45,000
8,500		10,000	89,000	47,000	40,000	12,500		14,000	107,000	60,000	45,000
8,600		10,000	89,000	47,000	40,000	12,600		14,000	107,000	60,000	45,000
8,700		10,000	89,000	47,000	40,000	12,700	1/2	14,000	107,000	60,000	45,000
8,730	11/32	10,000	89,000	47,000	40,000	12,800		14,000	107,000	60,000	45,000
8,800		10,000	89,000	47,000	40,000	13,000		14,000	107,000	60,000	45,000
8,900		10,000	89,000	47,000	40,000	13,100	33/64	14,000	107,000	60,000	45,000
9,000		10,000	89,000	47,000	40,000	13,200		14,000	107,000	60,000	45,000
9,100		10,000	89,000	47,000	40,000	13,300		14,000	107,000	60,000	45,000
9,130	23/64	10,000	89,000	47,000	40,000	13,500		14,000	107,000	60,000	45,000
9,200		10,000	89,000	47,000	40,000	13,700		14,000	107,000	60,000	45,000
9,250		10,000	89,000	47,000	40,000	13,800		14,000	107,000	60,000	45,000
9,300		10,000	89,000	47,000	40,000	14,000		14,000	107,000	60,000	45,000
9,400		10,000	89,000	47,000	40,000	14,100		16,000	115,000	65,000	48,000
9,500		10,000	89,000	47,000	40,000	14,200		16,000	115,000	65,000	48,000
9,520	3/8	10,000	89,000	47,000	40,000	14,290	9/16	16,000	115,000	65,000	48,000
9,600		10,000	89,000	47,000	40,000	14,500		16,000	115,000	65,000	48,000
9,700		10,000	89,000	47,000	40,000	14,700		16,000	115,000	65,000	48,000
9,800		10,000	89,000	47,000	40,000	15,000		16,000	115,000	65,000	48,000
9,900		10,000	89,000	47,000	40,000	15,100		16,000	115,000	65,000	48,000
9,920	25/64	10,000	89,000	47,000	40,000	15,200		16,000	115,000	65,000	48,000
10,000		10,000	89,000	47,000	40,000	15,500		16,000	115,000	65,000	48,000
10,100		12,000	102,000	55,000	45,000	15,700		16,000	115,000	65,000	48,000
10,200		12,000	102,000	55,000	45,000	15,800		16,000	115,000	65,000	48,000
10,300		12,000	102,000	55,000	45,000	16,000		16,000	115,000	65,000	48,000
10,320	13/32	12,000	102,000	55,000	45,000	16,200		18,000	123,000	73,000	48,000
10,400		12,000	102,000	55,000	45,000	16,500		18,000	123,000	73,000	48,000
10,500		12,000	102,000	55,000	45,000	17,000		18,000	123,000	73,000	48,000
10,600		12,000	102,000	55,000	45,000	17,500		18,000	123,000	73,000	48,000
10,700		12,000	102,000	55,000	45,000	18,000		18,000	123,000	73,000	48,000
10,800		12,000	102,000	55,000	45,000	18,500		20,000	131,000	79,000	50,000
10,900		12,000	102,000	55,000	45,000	19,000		20,000	131,000	79,000	50,000
11,000		12,000	102,000	55,000	45,000	19,500		20,000	131,000	79,000	50,000
11,100		12,000	102,000	55,000	45,000	20,000		20,000	131,000	79,000	50,000
11,110	7/16	12,000	102,000	55,000	45,000						
11,200		12,000	102,000	55,000	45,000						
11,300		12,000	102,000	55,000	45,000						



TS-Drills ohne Innenkühlung

Artikel-Nr. 89414



P	M	K	N	S	H
●	○	●	○	○	○

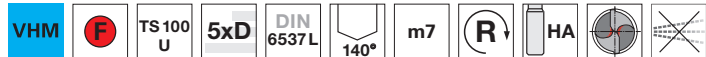

Ausspitzung ≥ Ø 3,000 • Flächenanschliff • Hauptschneidenform gerade • optimierte Schneidengeometrie
 Bau- und Einsatzstähle • Automatenstähle, Vergütungsstähle • Stähle (legiert/unleg.) bis 1200 N/mm² • Gusswerkstoffe • Bronzen, Messing • hochlegierte AISi-Legierungen

Artikel-Nr. 89417



P	M	K	N	S	H
●	○	●	○	○	○

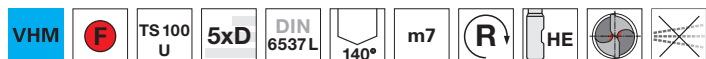

Ausspitzung ≥ Ø 3,000 • Flächenanschliff • Hauptschneidenform gerade • optimierte Schneidengeometrie
 Bau- und Einsatzstähle • Automatenstähle, Vergütungsstähle • Stähle (legiert/unleg.) bis 1200 N/mm² • Gusswerkstoffe • Bronzen, Messing • hochlegierte AISi-Legierungen

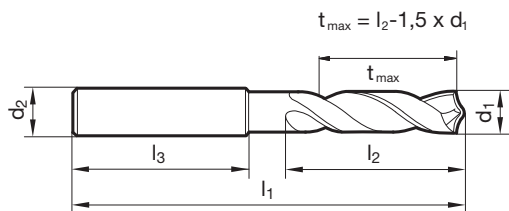

d1	inch	d2 h6	l1	l2	l3	d1	inch	d2 h6	l1	l2	l3
mm		mm	mm	mm	mm	mm		mm	mm	mm	mm
3,000		6,000	66,000	28,000	36,000	5,200		6,000	82,000	44,000	36,000
3,100		6,000	66,000	28,000	36,000	5,300		6,000	82,000	44,000	36,000
3,170	1/8	6,000	66,000	28,000	36,000	5,400		6,000	82,000	44,000	36,000
3,200		6,000	66,000	28,000	36,000	5,500		6,000	82,000	44,000	36,000
3,250		6,000	66,000	28,000	36,000	5,550		6,000	82,000	44,000	36,000
3,300		6,000	66,000	28,000	36,000	5,560	7/32	6,000	82,000	44,000	36,000
3,400		6,000	66,000	28,000	36,000	5,600		6,000	82,000	44,000	36,000
3,500		6,000	66,000	28,000	36,000	5,700		6,000	82,000	44,000	36,000
3,570	9/64	6,000	66,000	28,000	36,000	5,800		6,000	82,000	44,000	36,000
3,600		6,000	66,000	28,000	36,000	5,900		6,000	82,000	44,000	36,000
3,700		6,000	66,000	28,000	36,000	5,950	15/64	6,000	82,000	44,000	36,000
3,800		6,000	74,000	36,000	36,000	6,000		6,000	82,000	44,000	36,000
3,900		6,000	74,000	36,000	36,000	6,100		8,000	91,000	53,000	36,000
3,970	5/32	6,000	74,000	36,000	36,000	6,200		8,000	91,000	53,000	36,000
4,000		6,000	74,000	36,000	36,000	6,300		8,000	91,000	53,000	36,000
4,100		6,000	74,000	36,000	36,000	6,350	1/4	8,000	91,000	53,000	36,000
4,200		6,000	74,000	36,000	36,000	6,400		8,000	91,000	53,000	36,000
4,300		6,000	74,000	36,000	36,000	6,500		8,000	91,000	53,000	36,000
4,370	11/64	6,000	74,000	36,000	36,000	6,600		8,000	91,000	53,000	36,000
4,400		6,000	74,000	36,000	36,000	6,700		8,000	91,000	53,000	36,000
4,500		6,000	74,000	36,000	36,000	6,750	17/64	8,000	91,000	53,000	36,000
4,600		6,000	74,000	36,000	36,000	6,800		8,000	91,000	53,000	36,000
4,650		6,000	74,000	36,000	36,000	6,900		8,000	91,000	53,000	36,000
4,700		6,000	74,000	36,000	36,000	7,000		8,000	91,000	53,000	36,000
4,760	3/16	6,000	82,000	44,000	36,000	7,100		8,000	91,000	53,000	36,000
4,800		6,000	82,000	44,000	36,000	7,140	9/32	8,000	91,000	53,000	36,000
4,900		6,000	82,000	44,000	36,000	7,200		8,000	91,000	53,000	36,000
5,000		6,000	82,000	44,000	36,000	7,300		8,000	91,000	53,000	36,000
5,100		6,000	82,000	44,000	36,000	7,400		8,000	91,000	53,000	36,000
5,160	13/64	6,000	82,000	44,000	36,000	7,500		8,000	91,000	53,000	36,000



TS-Drills ohne Innenkühlung

d1 mm	inch	d2 h6 mm	l1 mm	l2 mm	l3 mm	d1 mm	inch	d2 h6 mm	l1 mm	l2 mm	l3 mm
7,540	19/64	8,000	91,000	53,000	36,000	11,400		12,000	118,000	71,000	45,000
7,600		8,000	91,000	53,000	36,000	11,500		12,000	118,000	71,000	45,000
7,700		8,000	91,000	53,000	36,000	11,600		12,000	118,000	71,000	45,000
7,800		8,000	91,000	53,000	36,000	11,700		12,000	118,000	71,000	45,000
7,900		8,000	91,000	53,000	36,000	11,800		12,000	118,000	71,000	45,000
7,940	5/16	8,000	91,000	53,000	36,000	11,900		12,000	118,000	71,000	45,000
8,000		8,000	91,000	53,000	36,000	11,910	15/32	12,000	118,000	71,000	45,000
8,100		10,000	103,000	61,000	40,000	12,000		12,000	118,000	71,000	45,000
8,200		10,000	103,000	61,000	40,000	12,100		14,000	124,000	77,000	45,000
8,300		10,000	103,000	61,000	40,000	12,200		14,000	124,000	77,000	45,000
8,330	21/64	10,000	103,000	61,000	40,000	12,500		14,000	124,000	77,000	45,000
8,400		10,000	103,000	61,000	40,000	12,700	1/2	14,000	124,000	77,000	45,000
8,500		10,000	103,000	61,000	40,000	13,000		14,000	124,000	77,000	45,000
8,600		10,000	103,000	61,000	40,000	13,100	33/64	14,000	124,000	77,000	45,000
8,700		10,000	103,000	61,000	40,000	13,500		14,000	124,000	77,000	45,000
8,730	11/32	10,000	103,000	61,000	40,000	13,700		14,000	124,000	77,000	45,000
8,800		10,000	103,000	61,000	40,000	13,800		14,000	124,000	77,000	45,000
8,900		10,000	103,000	61,000	40,000	14,000		14,000	124,000	77,000	45,000
9,000		10,000	103,000	61,000	40,000	14,100		16,000	133,000	83,000	48,000
9,100		10,000	103,000	61,000	40,000	14,200		16,000	133,000	83,000	48,000
9,130	23/64	10,000	103,000	61,000	40,000	14,290	9/16	16,000	133,000	83,000	48,000
9,200		10,000	103,000	61,000	40,000	14,500		16,000	133,000	83,000	48,000
9,250		10,000	103,000	61,000	40,000	14,700		16,000	133,000	83,000	48,000
9,300		10,000	103,000	61,000	40,000	15,000		16,000	133,000	83,000	48,000
9,400		10,000	103,000	61,000	40,000	15,100		16,000	133,000	83,000	48,000
9,500		10,000	103,000	61,000	40,000	15,200		16,000	133,000	83,000	48,000
9,520	3/8	10,000	103,000	61,000	40,000	15,500		16,000	133,000	83,000	48,000
9,600		10,000	103,000	61,000	40,000	15,700		16,000	133,000	83,000	48,000
9,700		10,000	103,000	61,000	40,000	16,000		16,000	133,000	83,000	48,000
9,800		10,000	103,000	61,000	40,000	16,500		18,000	143,000	93,000	48,000
9,900		10,000	103,000	61,000	40,000	17,000		18,000	143,000	93,000	48,000
9,920	25/64	10,000	103,000	61,000	40,000	17,500		18,000	143,000	93,000	48,000
10,000		10,000	103,000	61,000	40,000	18,000		18,000	143,000	93,000	48,000
10,100		12,000	118,000	71,000	45,000	18,500		20,000	153,000	101,000	50,000
10,200		12,000	118,000	71,000	45,000	19,000		20,000	153,000	101,000	50,000
10,300		12,000	118,000	71,000	45,000	19,500		20,000	153,000	101,000	50,000
10,320	13/32	12,000	118,000	71,000	45,000	20,000		20,000	153,000	101,000	50,000
10,400		12,000	118,000	71,000	45,000						
10,500		12,000	118,000	71,000	45,000						
10,600		12,000	118,000	71,000	45,000						
10,700		12,000	118,000	71,000	45,000						
10,800		12,000	118,000	71,000	45,000						
10,900		12,000	118,000	71,000	45,000						
11,000		12,000	118,000	71,000	45,000						
11,100		12,000	118,000	71,000	45,000						
11,110	7/16	12,000	118,000	71,000	45,000						
11,200		12,000	118,000	71,000	45,000						
11,300		12,000	118,000	71,000	45,000						



TS-Drills mit Innenkühlung

Artikel-Nr. 89410



P	M	K	N	S	H
●	○	●	○	○	○

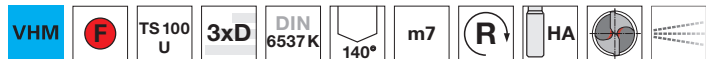

Ausspitzung ≥ Ø 3,000 • Flächenanschliff • Hauptschneidenform gerade • optimierte Schneidengeometrie
 Bau- und Einsatzstähle • Automatenstähle, Vergütungsstähle • Stähle (legiert/unleg.) bis 1200 N/mm² • Gusswerkstoffe • Bronzen, Messing • hochlegierte AISi-Legierungen

Artikel-Nr. 89415



P	M	K	N	S	H
●	○	●	○	○	○

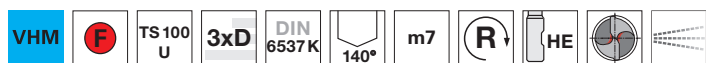

Ausspitzung ≥ Ø 3,000 • Flächenanschliff • Hauptschneidenform gerade • optimierte Schneidengeometrie
 Bau- und Einsatzstähle • Automatenstähle, Vergütungsstähle • Stähle (legiert/unleg.) bis 1200 N/mm² • Gusswerkstoffe • Bronzen, Messing • hochlegierte AISi-Legierungen

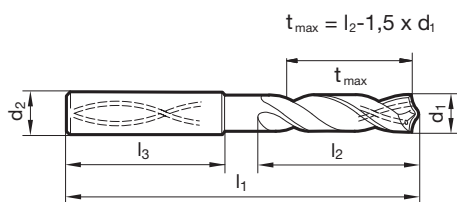

d1	inch	d2 h6	l1	l2	l3	d1	inch	d2 h6	l1	l2	l3
mm		mm	mm	mm	mm	mm		mm	mm	mm	mm
3,000		6,000	62,000	20,000	36,000	5,200		6,000	66,000	28,000	36,000
3,100		6,000	62,000	20,000	36,000	5,300		6,000	66,000	28,000	36,000
3,170	1/8	6,000	62,000	20,000	36,000	5,400		6,000	66,000	28,000	36,000
3,200		6,000	62,000	20,000	36,000	5,500		6,000	66,000	28,000	36,000
3,250		6,000	62,000	20,000	36,000	5,550		6,000	66,000	28,000	36,000
3,300		6,000	62,000	20,000	36,000	5,560	7/32	6,000	66,000	28,000	36,000
3,400		6,000	62,000	20,000	36,000	5,600		6,000	66,000	28,000	36,000
3,500		6,000	62,000	20,000	36,000	5,700		6,000	66,000	28,000	36,000
3,570	9/64	6,000	62,000	20,000	36,000	5,800		6,000	66,000	28,000	36,000
3,600		6,000	62,000	20,000	36,000	5,900		6,000	66,000	28,000	36,000
3,700		6,000	62,000	20,000	36,000	5,950	15/64	6,000	66,000	28,000	36,000
3,800		6,000	66,000	24,000	36,000	6,000		6,000	66,000	28,000	36,000
3,900		6,000	66,000	24,000	36,000	6,100		8,000	79,000	34,000	36,000
3,970	5/32	6,000	66,000	24,000	36,000	6,200		8,000	79,000	34,000	36,000
4,000		6,000	66,000	24,000	36,000	6,300		8,000	79,000	34,000	36,000
4,100		6,000	66,000	24,000	36,000	6,350	1/4	8,000	79,000	34,000	36,000
4,200		6,000	66,000	24,000	36,000	6,400		8,000	79,000	34,000	36,000
4,300		6,000	66,000	24,000	36,000	6,500		8,000	79,000	34,000	36,000
4,370	11/64	6,000	66,000	24,000	36,000	6,600		8,000	79,000	34,000	36,000
4,400		6,000	66,000	24,000	36,000	6,700		8,000	79,000	34,000	36,000
4,500		6,000	66,000	24,000	36,000	6,750	17/64	8,000	79,000	34,000	36,000
4,600		6,000	66,000	24,000	36,000	6,800		8,000	79,000	34,000	36,000
4,650		6,000	66,000	24,000	36,000	6,900		8,000	79,000	34,000	36,000
4,700		6,000	66,000	24,000	36,000	7,000		8,000	79,000	34,000	36,000
4,760	3/16	6,000	66,000	28,000	36,000	7,100		8,000	79,000	41,000	36,000
4,800		6,000	66,000	28,000	36,000	7,140	9/32	8,000	79,000	41,000	36,000
4,900		6,000	66,000	28,000	36,000	7,200		8,000	79,000	41,000	36,000
5,000		6,000	66,000	28,000	36,000	7,300		8,000	79,000	41,000	36,000
5,100		6,000	66,000	28,000	36,000	7,400		8,000	79,000	41,000	36,000
5,160	13/64	6,000	66,000	28,000	36,000	7,500		8,000	79,000	41,000	36,000



TS-Drills mit Innenkühlung

d1 mm	inch	d2 h6 mm	l1 mm	l2 mm	l3 mm	d1 mm	inch	d2 h6 mm	l1 mm	l2 mm	l3 mm
7,540	19/64	8,000	79,000	41,000	36,000	11,400		12,000	102,000	55,000	45,000
7,600		8,000	79,000	41,000	36,000	11,500		12,000	102,000	55,000	45,000
7,700		8,000	79,000	41,000	36,000	11,600		12,000	102,000	55,000	45,000
7,800		8,000	79,000	41,000	36,000	11,700		12,000	102,000	55,000	45,000
7,900		8,000	79,000	41,000	36,000	11,800		12,000	102,000	55,000	45,000
7,940	5/16	8,000	79,000	41,000	36,000	11,900		12,000	102,000	55,000	45,000
8,000		8,000	79,000	41,000	36,000	11,910	15/32	12,000	102,000	55,000	45,000
8,100		10,000	89,000	47,000	40,000	12,000		12,000	102,000	55,000	45,000
8,200		10,000	89,000	47,000	40,000	12,100		14,000	107,000	60,000	45,000
8,300		10,000	89,000	47,000	40,000	12,200		14,000	107,000	60,000	45,000
8,330	21/64	10,000	89,000	47,000	40,000	12,300	31/64	14,000	107,000	60,000	45,000
8,400		10,000	89,000	47,000	40,000	12,500		14,000	107,000	60,000	45,000
8,500		10,000	89,000	47,000	40,000	12,700	1/2	14,000	107,000	60,000	45,000
8,600		10,000	89,000	47,000	40,000	13,000		14,000	107,000	60,000	45,000
8,700		10,000	89,000	47,000	40,000	13,100	33/64	14,000	107,000	60,000	45,000
8,730	11/32	10,000	89,000	47,000	40,000	13,200		14,000	107,000	60,000	45,000
8,800		10,000	89,000	47,000	40,000	13,300		14,000	107,000	60,000	45,000
8,900		10,000	89,000	47,000	40,000	13,500		14,000	107,000	60,000	45,000
9,000		10,000	89,000	47,000	40,000	13,700		14,000	107,000	60,000	45,000
9,100		10,000	89,000	47,000	40,000	14,000		14,000	107,000	60,000	45,000
9,130	23/64	10,000	89,000	47,000	40,000	14,100		16,000	115,000	65,000	48,000
9,200		10,000	89,000	47,000	40,000	14,200		16,000	115,000	65,000	48,000
9,250		10,000	89,000	47,000	40,000	14,290	9/16	16,000	115,000	65,000	48,000
9,300		10,000	89,000	47,000	40,000	14,400		16,000	115,000	65,000	48,000
9,400		10,000	89,000	47,000	40,000	14,500		16,000	115,000	65,000	48,000
9,500		10,000	89,000	47,000	40,000	14,600		16,000	115,000	65,000	48,000
9,520	3/8	10,000	89,000	47,000	40,000	14,700		16,000	115,000	65,000	48,000
9,600		10,000	89,000	47,000	40,000	15,000		16,000	115,000	65,000	48,000
9,700		10,000	89,000	47,000	40,000	15,200		16,000	115,000	65,000	48,000
9,800		10,000	89,000	47,000	40,000	15,500		16,000	115,000	65,000	48,000
9,900		10,000	89,000	47,000	40,000	15,700		16,000	115,000	65,000	48,000
9,920	25/64	10,000	89,000	47,000	40,000	16,000		16,000	115,000	65,000	48,000
10,000		10,000	89,000	47,000	40,000	16,100		18,000	123,000	73,000	48,000
10,100		12,000	102,000	55,000	45,000	16,500		18,000	123,000	73,000	48,000
10,200		12,000	102,000	55,000	45,000	16,900		18,000	123,000	73,000	48,000
10,300		12,000	102,000	55,000	45,000	17,000		18,000	123,000	73,000	48,000
10,320	13/32	12,000	102,000	55,000	45,000	17,300		18,000	123,000	73,000	48,000
10,400		12,000	102,000	55,000	45,000	17,500		18,000	123,000	73,000	48,000
10,500		12,000	102,000	55,000	45,000	17,700		18,000	123,000	73,000	48,000
10,600		12,000	102,000	55,000	45,000	18,000		18,000	123,000	73,000	48,000
10,700		12,000	102,000	55,000	45,000	18,500		20,000	131,000	79,000	50,000
10,800		12,000	102,000	55,000	45,000	18,900		20,000	131,000	79,000	50,000
10,900		12,000	102,000	55,000	45,000	19,000		20,000	131,000	79,000	50,000
11,000		12,000	102,000	55,000	45,000	19,500		20,000	131,000	79,000	50,000
11,100		12,000	102,000	55,000	45,000	20,000		20,000	131,000	79,000	50,000
11,110	7/16	12,000	102,000	55,000	45,000						
11,200		12,000	102,000	55,000	45,000						
11,300		12,000	102,000	55,000	45,000						



TS-Drills mit Innenkühlung

Artikel-Nr. 89411



P	M	K	N	S	H
●	○	●	○	○	○

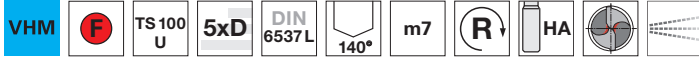

Ausspitzung ≥ Ø 3,000 • Flächenanschliff • Hauptschneidenform gerade • optimierte Schneidengeometrie
 Bau- und Einsatzstähle • Automatenstähle, Vergütungsstähle • Stähle (legiert/unleg.) bis 1200 N/mm² • Gusswerkstoffe • Bronzen, Messing • hochlegierte AISi-Legierungen

Artikel-Nr. 89408



P	M	K	N	S	H
●	○	●	○	○	○

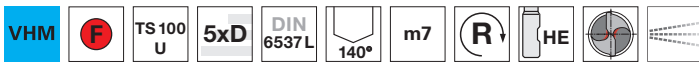

Ausspitzung ≥ Ø 3,000 • Flächenanschliff • Hauptschneidenform gerade • optimierte Schneidengeometrie
 Bau- und Einsatzstähle • Automatenstähle, Vergütungsstähle • Stähle (legiert/unleg.) bis 1200 N/mm² • Gusswerkstoffe • Bronzen, Messing • hochlegierte AISi-Legierungen

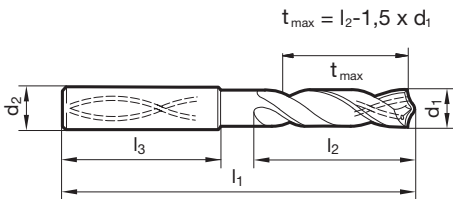

d1	inch	d2 h6	l1	l2	l3	d1	inch	d2 h6	l1	l2	l3
mm		mm	mm	mm	mm	mm		mm	mm	mm	mm
3,000		6,000	66,000	28,000	36,000	5,200		6,000	82,000	44,000	36,000
3,100		6,000	66,000	28,000	36,000	5,300		6,000	82,000	44,000	36,000
3,170	1/8	6,000	66,000	28,000	36,000	5,400		6,000	82,000	44,000	36,000
3,200		6,000	66,000	28,000	36,000	5,500		6,000	82,000	44,000	36,000
3,250		6,000	66,000	28,000	36,000	5,550		6,000	82,000	44,000	36,000
3,300		6,000	66,000	28,000	36,000	5,560	7/32	6,000	82,000	44,000	36,000
3,400		6,000	66,000	28,000	36,000	5,600		6,000	82,000	44,000	36,000
3,500		6,000	66,000	28,000	36,000	5,700		6,000	82,000	44,000	36,000
3,570	9/64	6,000	66,000	28,000	36,000	5,800		6,000	82,000	44,000	36,000
3,600		6,000	66,000	28,000	36,000	5,900		6,000	82,000	44,000	36,000
3,700		6,000	66,000	28,000	36,000	5,950	15/64	6,000	82,000	44,000	36,000
3,800		6,000	74,000	36,000	36,000	6,000		6,000	82,000	44,000	36,000
3,900		6,000	74,000	36,000	36,000	6,100		8,000	91,000	53,000	36,000
3,970	5/32	6,000	74,000	36,000	36,000	6,200		8,000	91,000	53,000	36,000
4,000		6,000	74,000	36,000	36,000	6,300		8,000	91,000	53,000	36,000
4,100		6,000	74,000	36,000	36,000	6,350	1/4	8,000	91,000	53,000	36,000
4,200		6,000	74,000	36,000	36,000	6,400		8,000	91,000	53,000	36,000
4,300		6,000	74,000	36,000	36,000	6,500		8,000	91,000	53,000	36,000
4,370	11/64	6,000	74,000	36,000	36,000	6,600		8,000	91,000	53,000	36,000
4,400		6,000	74,000	36,000	36,000	6,700		8,000	91,000	53,000	36,000
4,500		6,000	74,000	36,000	36,000	6,750	17/64	8,000	91,000	53,000	36,000
4,600		6,000	74,000	36,000	36,000	6,800		8,000	91,000	53,000	36,000
4,650		6,000	74,000	36,000	36,000	6,900		8,000	91,000	53,000	36,000
4,700		6,000	74,000	36,000	36,000	7,000		8,000	91,000	53,000	36,000
4,760	3/16	6,000	82,000	44,000	36,000	7,100		8,000	91,000	53,000	36,000
4,800		6,000	82,000	44,000	36,000	7,140	9/32	8,000	91,000	53,000	36,000
4,900		6,000	82,000	44,000	36,000	7,200		8,000	91,000	53,000	36,000
5,000		6,000	82,000	44,000	36,000	7,300		8,000	91,000	53,000	36,000
5,100		6,000	82,000	44,000	36,000	7,400		8,000	91,000	53,000	36,000
5,160	13/64	6,000	82,000	44,000	36,000	7,500		8,000	91,000	53,000	36,000



TS-Drills mit Innenkühlung

d1 mm	inch	d2 h6 mm	l1 mm	l2 mm	l3 mm	d1 mm	inch	d2 h6 mm	l1 mm	l2 mm	l3 mm
7,540	19/64	8,000	91,000	53,000	36,000	11,910	15/32	12,000	118,000	71,000	45,000
7,600		8,000	91,000	53,000	36,000	12,000		12,000	118,000	71,000	45,000
7,700		8,000	91,000	53,000	36,000	12,100		14,000	124,000	77,000	45,000
7,800		8,000	91,000	53,000	36,000	12,200		14,000	124,000	77,000	45,000
7,900		8,000	91,000	53,000	36,000	12,300	31/64	14,000	124,000	77,000	45,000
7,940	5/16	8,000	91,000	53,000	36,000	12,400		14,000	124,000	77,000	45,000
8,000		8,000	91,000	53,000	36,000	12,500		14,000	124,000	77,000	45,000
8,100		10,000	103,000	61,000	40,000	12,600		14,000	124,000	77,000	45,000
8,200		10,000	103,000	61,000	40,000	12,700	1/2	14,000	124,000	77,000	45,000
8,300		10,000	103,000	61,000	40,000	12,800		14,000	124,000	77,000	45,000
8,330	21/64	10,000	103,000	61,000	40,000	13,000		14,000	124,000	77,000	45,000
8,400		10,000	103,000	61,000	40,000	13,100	33/64	14,000	124,000	77,000	45,000
8,500		10,000	103,000	61,000	40,000	13,300		14,000	124,000	77,000	45,000
8,600		10,000	103,000	61,000	40,000	13,500		14,000	124,000	77,000	45,000
8,700		10,000	103,000	61,000	40,000	13,700		14,000	124,000	77,000	45,000
8,730	11/32	10,000	103,000	61,000	40,000	13,800		14,000	124,000	77,000	45,000
8,800		10,000	103,000	61,000	40,000	14,000		14,000	124,000	77,000	45,000
8,900		10,000	103,000	61,000	40,000	14,100		16,000	133,000	83,000	48,000
9,000		10,000	103,000	61,000	40,000	14,200		16,000	133,000	83,000	48,000
9,100		10,000	103,000	61,000	40,000	14,290	9/16	16,000	133,000	83,000	48,000
9,130	23/64	10,000	103,000	61,000	40,000	14,500		16,000	133,000	83,000	48,000
9,200		10,000	103,000	61,000	40,000	14,600		16,000	133,000	83,000	48,000
9,250		10,000	103,000	61,000	40,000	14,700		16,000	133,000	83,000	48,000
9,300		10,000	103,000	61,000	40,000	14,800		16,000	133,000	83,000	48,000
9,400		10,000	103,000	61,000	40,000	15,000		16,000	133,000	83,000	48,000
9,500		10,000	103,000	61,000	40,000	15,100		16,000	133,000	83,000	48,000
9,520	3/8	10,000	103,000	61,000	40,000	15,200		16,000	133,000	83,000	48,000
9,600		10,000	103,000	61,000	40,000	15,300		16,000	133,000	83,000	48,000
9,700		10,000	103,000	61,000	40,000	15,500		16,000	133,000	83,000	48,000
9,800		10,000	103,000	61,000	40,000	15,700		16,000	133,000	83,000	48,000
9,900		10,000	103,000	61,000	40,000	15,800		16,000	133,000	83,000	48,000
9,920	25/64	10,000	103,000	61,000	40,000	16,000		16,000	133,000	83,000	48,000
10,000		10,000	103,000	61,000	40,000	16,500		18,000	143,000	93,000	48,000
10,100		12,000	118,000	71,000	45,000	16,900		18,000	143,000	93,000	48,000
10,200		12,000	118,000	71,000	45,000	17,000		18,000	143,000	93,000	48,000
10,300		12,000	118,000	71,000	45,000	17,500		18,000	143,000	93,000	48,000
10,320	13/32	12,000	118,000	71,000	45,000	18,000		18,000	143,000	93,000	48,000
10,400		12,000	118,000	71,000	45,000	18,500		20,000	153,000	101,000	50,000
10,500		12,000	118,000	71,000	45,000	18,900		20,000	153,000	101,000	50,000
10,600		12,000	118,000	71,000	45,000	19,000		20,000	153,000	101,000	50,000
10,700		12,000	118,000	71,000	45,000	19,050	3/4	20,000	153,000	101,000	50,000
10,800		12,000	118,000	71,000	45,000	19,500		20,000	153,000	101,000	50,000
10,900		12,000	118,000	71,000	45,000	20,000		20,000	153,000	101,000	50,000
11,000		12,000	118,000	71,000	45,000						
11,100		12,000	118,000	71,000	45,000						
11,110	7/16	12,000	118,000	71,000	45,000						
11,200		12,000	118,000	71,000	45,000						
11,300		12,000	118,000	71,000	45,000						
11,400		12,000	118,000	71,000	45,000						
11,500		12,000	118,000	71,000	45,000						
11,600		12,000	118,000	71,000	45,000						
11,700		12,000	118,000	71,000	45,000						
11,800		12,000	118,000	71,000	45,000						
11,900		12,000	118,000	71,000	45,000						



TS-Drills mit Innenkühlung

Artikel-Nr. 89412



P	M	K	N	S	H
●	○	●	○	○	○

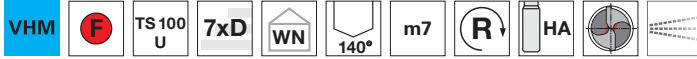

Ausspitzung ≥ Ø 3,000 • Flächenanschliff • Hauptschneidenform gerade • optimierte Schneidengeometrie
 Bau- und Einsatzstähle • Automatenstähle, Vergütungsstähle • Stähle (legiert/unleg.) bis 1200 N/mm² • Gusswerkstoffe • Bronzen, Messing • hochlegierte AISi-Legierungen

Artikel-Nr. 89416



P	M	K	N	S	H
●	○	●	○	○	○



Ausspitzung ≥ Ø 3,000 • Flächenanschliff • Hauptschneidenform gerade • optimierte Schneidengeometrie
 Bau- und Einsatzstähle • Automatenstähle, Vergütungsstähle • Stähle (legiert/unleg.) bis 1200 N/mm² • Gusswerkstoffe • Bronzen, Messing • hochlegierte AISi-Legierungen

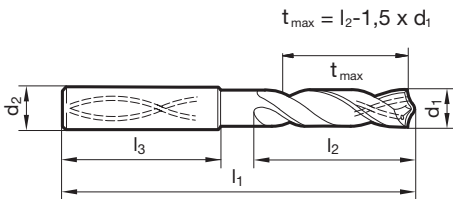

d1	inch	d2 h6	l1	l2	l3	d1	inch	d2 h6	l1	l2	l3
mm		mm	mm	mm	mm	mm		mm	mm	mm	mm
3,000		6,000	70,000	30,000	36,000	5,200		6,000	90,000	50,000	36,000
3,100		6,000	70,000	30,000	36,000	5,300		6,000	90,000	50,000	36,000
3,170	1/8	6,000	70,000	30,000	36,000	5,400		6,000	97,000	57,000	36,000
3,200		6,000	70,000	30,000	36,000	5,500		6,000	97,000	57,000	36,000
3,250		6,000	70,000	30,000	36,000	5,700		6,000	97,000	57,000	36,000
3,300		6,000	70,000	30,000	36,000	5,800		6,000	97,000	57,000	36,000
3,400		6,000	75,000	35,500	36,000	5,900		6,000	97,000	57,000	36,000
3,500		6,000	75,000	35,500	36,000	5,950	15/64	6,000	97,000	57,000	36,000
3,570	9/64	6,000	75,000	35,500	36,000	6,000		6,000	97,000	57,000	36,000
3,600		6,000	75,000	35,500	36,000	6,200		8,000	106,000	66,000	36,000
3,700		6,000	75,000	35,500	36,000	6,300		8,000	106,000	66,000	36,000
3,800		6,000	75,000	37,500	36,000	6,350	1/4	8,000	106,000	66,000	36,000
3,900		6,000	75,000	37,500	36,000	6,500		8,000	106,000	66,000	36,000
3,970	5/32	6,000	75,000	37,500	36,000	6,600		8,000	106,000	66,000	36,000
4,000		6,000	75,000	37,500	36,000	6,700		8,000	106,000	66,000	36,000
4,100		6,000	75,000	37,500	36,000	6,800		8,000	106,000	66,000	36,000
4,200		6,000	75,000	37,500	36,000	6,900		8,000	116,000	76,000	36,000
4,300		6,000	85,000	45,000	36,000	7,000		8,000	116,000	76,000	36,000
4,370	11/64	6,000	85,000	45,000	36,000	7,100		8,000	116,000	76,000	36,000
4,400		6,000	85,000	45,000	36,000	7,200		8,000	116,000	76,000	36,000
4,500		6,000	85,000	45,000	36,000	7,500		8,000	116,000	76,000	36,000
4,600		6,000	85,000	45,000	36,000	7,600		8,000	116,000	76,000	36,000
4,650		6,000	85,000	45,000	36,000	7,700		8,000	116,000	76,000	36,000
4,700		6,000	85,000	45,000	36,000	7,800		8,000	116,000	76,000	36,000
4,760	3/16	6,000	90,000	50,000	36,000	8,000		8,000	116,000	76,000	36,000
4,800		6,000	90,000	50,000	36,000	8,100		10,000	131,000	87,000	40,000
4,900		6,000	90,000	50,000	36,000	8,200		10,000	131,000	87,000	40,000
5,000		6,000	90,000	50,000	36,000	8,400		10,000	131,000	87,000	40,000
5,100		6,000	90,000	50,000	36,000	8,500		10,000	131,000	87,000	40,000
5,160	13/64	6,000	90,000	50,000	36,000	8,600		10,000	131,000	87,000	40,000



TS-Drills mit Innenkühlung

d1 mm	inch	d2 h6 mm	l1 mm	l2 mm	l3 mm	d1 mm	inch	d2 h6 mm	l1 mm	l2 mm	l3 mm
8,700		10,000	131,000	87,000	40,000	14,000		14,000	182,000	133,000	45,000
8,800		10,000	131,000	87,000	40,000	14,100		16,000	204,000	152,000	48,000
9,000		10,000	131,000	87,000	40,000	14,200		16,000	204,000	152,000	48,000
9,100		10,000	139,000	95,000	40,000	14,500		16,000	204,000	152,000	48,000
9,200		10,000	139,000	95,000	40,000	15,000		16,000	204,000	152,000	48,000
9,250		10,000	139,000	95,000	40,000	15,100		16,000	204,000	152,000	48,000
9,300		10,000	139,000	95,000	40,000	15,500		16,000	204,000	152,000	48,000
9,400		10,000	139,000	95,000	40,000	16,000		16,000	204,000	152,000	48,000
9,500		10,000	139,000	95,000	40,000	16,500		18,000	223,000	171,000	48,000
9,520	3/8	10,000	139,000	95,000	40,000	16,900		18,000	223,000	171,000	48,000
9,700		10,000	139,000	95,000	40,000	17,000		18,000	223,000	171,000	48,000
9,800		10,000	139,000	95,000	40,000	17,500		18,000	223,000	171,000	48,000
9,900		10,000	139,000	95,000	40,000	18,000		18,000	223,000	171,000	48,000
10,000		10,000	139,000	95,000	40,000	18,500		20,000	244,000	190,000	50,000
10,200		12,000	155,000	106,000	45,000	18,900		20,000	244,000	190,000	50,000
10,300		12,000	155,000	106,000	45,000	19,000		20,000	244,000	190,000	50,000
10,500		12,000	155,000	106,000	45,000	19,050	3/4	20,000	244,000	190,000	50,000
10,800		12,000	155,000	106,000	45,000	19,500		20,000	244,000	190,000	50,000
11,000		12,000	155,000	106,000	45,000	20,000		20,000	244,000	190,000	50,000
11,200		12,000	163,000	114,000	45,000						
11,500		12,000	163,000	114,000	45,000						
11,800		12,000	163,000	114,000	45,000						
12,000		12,000	163,000	114,000	45,000						
12,100		14,000	182,000	133,000	45,000						
12,200		14,000	182,000	133,000	45,000						
12,500		14,000	182,000	133,000	45,000						
12,700	1/2	14,000	182,000	133,000	45,000						
13,000		14,000	182,000	133,000	45,000						
13,100	33/64	14,000	182,000	133,000	45,000						
13,500		14,000	182,000	133,000	45,000						



TS-Drills mit Innenkühlung

Artikel-Nr. 89418



P	M	K	N	S	H
●	○	●	○	○	○

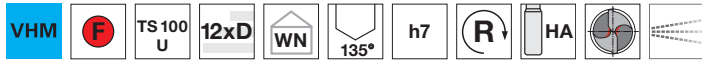

Ausspitzung ≥ Ø 3,000 • Flächenanschliff • Kopfbeschichtung • Hauptschneidenform gerade • optimierte Schneidengeometrie
 Bau- und Einsatzstähle • Automatenstähle, Vergütungsstähle • Stähle (legiert/unleg.) bis 1200 N/mm² • Gusswerkstoffe • Bronzen, Messing • hochlegierte AISI-Legierungen

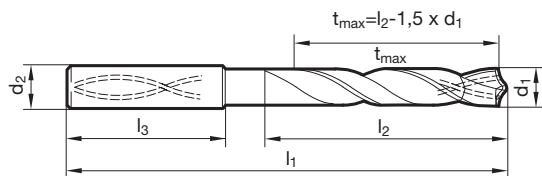

d1	inch	d2 h6	l1	l2	l3	d1	inch	d2 h6	l1	l2	l3
mm		mm	mm	mm	mm	mm		mm	mm	mm	mm
3,000		6,000	90,000	50,000	36,000	7,000		8,000	146,000	108,000	36,000
3,100		6,000	90,000	50,000	36,000	7,100		8,000	146,000	108,000	36,000
3,170	1/8	6,000	90,000	50,000	36,000	7,200		8,000	146,000	108,000	36,000
3,200		6,000	90,000	50,000	36,000	7,300		8,000	146,000	108,000	36,000
3,300		6,000	90,000	50,000	36,000	7,400		8,000	146,000	108,000	36,000
3,400		6,000	90,000	50,000	36,000	7,500		8,000	146,000	108,000	36,000
3,500		6,000	90,000	50,000	36,000	7,600		8,000	146,000	108,000	36,000
3,600		6,000	90,000	50,000	36,000	7,700		8,000	146,000	108,000	36,000
3,700		6,000	90,000	50,000	36,000	7,800		8,000	146,000	108,000	36,000
3,800		6,000	102,000	64,000	36,000	7,900		8,000	146,000	108,000	36,000
3,900		6,000	102,000	64,000	36,000	8,000		8,000	146,000	108,000	36,000
4,000		6,000	102,000	64,000	36,000	8,100		10,000	162,000	120,000	40,000
4,100		6,000	102,000	64,000	36,000	8,200		10,000	162,000	120,000	40,000
4,200		6,000	102,000	64,000	36,000	8,300		10,000	162,000	120,000	40,000
4,300		6,000	102,000	64,000	36,000	8,400		10,000	162,000	120,000	40,000
4,400		6,000	102,000	64,000	36,000	8,500		10,000	162,000	120,000	40,000
4,500		6,000	102,000	64,000	36,000	8,600		10,000	162,000	120,000	40,000
4,600		6,000	102,000	64,000	36,000	8,700		10,000	162,000	120,000	40,000
4,700		6,000	102,000	64,000	36,000	8,800		10,000	162,000	120,000	40,000
4,800		6,000	116,000	78,000	36,000	8,900		10,000	162,000	120,000	40,000
4,900		6,000	116,000	78,000	36,000	9,000		10,000	162,000	120,000	40,000
5,000		6,000	116,000	78,000	36,000	9,100		10,000	162,000	120,000	40,000
5,100		6,000	116,000	78,000	36,000	9,200		10,000	162,000	120,000	40,000
5,200		6,000	116,000	78,000	36,000	9,300		10,000	162,000	120,000	40,000
5,300		6,000	116,000	78,000	36,000	9,400		10,000	162,000	120,000	40,000
5,400		6,000	116,000	78,000	36,000	9,500		10,000	162,000	120,000	40,000
5,500		6,000	116,000	78,000	36,000	9,520	3/8	10,000	162,000	120,000	40,000
5,600		6,000	116,000	78,000	36,000	9,600		10,000	162,000	120,000	40,000
5,700		6,000	116,000	78,000	36,000	9,700		10,000	162,000	120,000	40,000
5,800		6,000	116,000	78,000	36,000	9,800		10,000	162,000	120,000	40,000
5,900		6,000	116,000	78,000	36,000	9,900		10,000	162,000	120,000	40,000
6,000		6,000	116,000	78,000	36,000	10,000		10,000	162,000	120,000	40,000
6,100		8,000	146,000	108,000	36,000	10,200		12,000	204,000	156,000	45,000
6,200		8,000	146,000	108,000	36,000	10,500		12,000	204,000	156,000	45,000
6,300		8,000	146,000	108,000	36,000	11,000		12,000	204,000	156,000	45,000
6,350	1/4	8,000	146,000	108,000	36,000	11,500		12,000	204,000	156,000	45,000
6,400		8,000	146,000	108,000	36,000	12,000		12,000	204,000	156,000	45,000
6,500		8,000	146,000	108,000	36,000	12,500		14,000	230,000	182,000	45,000
6,600		8,000	146,000	108,000	36,000	12,700	1/2	14,000	230,000	182,000	45,000
6,700		8,000	146,000	108,000	36,000	13,000		14,000	230,000	182,000	45,000
6,800		8,000	146,000	108,000	36,000	13,500		14,000	230,000	182,000	45,000
6,900		8,000	146,000	108,000	36,000	14,000		14,000	230,000	182,000	45,000



TS-Drills mit Innenkühlung

d1 mm	inch	d2 h6 mm	l1 mm	l2 mm	l3 mm	d1 mm	inch	d2 h6 mm	l1 mm	l2 mm	l3 mm
14,500		16,000	260,000	208,000	48,000	20,000		20,000	310,000	258,000	50,000
15,000		16,000	260,000	208,000	48,000						
15,500		16,000	260,000	208,000	48,000						
16,000		16,000	260,000	208,000	48,000						
16,500		18,000	285,000	234,000	48,000						
17,000		18,000	285,000	234,000	48,000						
17,500		18,000	285,000	234,000	48,000						
18,000		18,000	285,000	234,000	48,000						
18,500		20,000	310,000	258,000	50,000						
19,000		20,000	310,000	258,000	50,000						
19,050	3/4	20,000	310,000	258,000	50,000						
19,500		20,000	310,000	258,000	50,000						

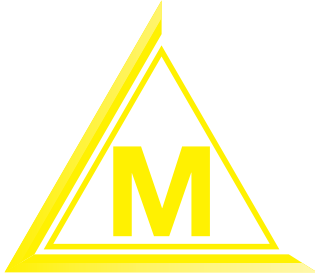

TS 100 INOX

▼ VORTEILE UND EIGENSCHAFTEN

- ▼ **Spezialist** für präzise Bohrungen und lange Standzeiten in rostfreien Stählen, säure- und hitzebeständigen Stählen, Inconel, Hastelloy, Nimonic, Titan und Titan-Legierungen
- ▼ mit dem **TS 100 INOX** können **hohe Vorschübe** gefahren werden – Späne werden schnell abgeführt und Aufbauschnneiden werden verhindert
- ▼ **Kühlkanäle** mit **maximalem Querschnitt** unterstützen die Wärme- und Spanabfuhr und wirken Aufbauschnneiden zusätzlich entgegen – **prozesssicheres Bohren** ist sichergestellt



ROST-, SÄURE- UND HITZEBESTÄNDIGE STÄHLE, TITAN UND TITANLEGIERUNGEN, SONDERLEGIERUNGEN

TS 100 INOX

Spezialausspitzung für exaktes Anbohren

scharfe, speziell auf die Zerspanung
von hochlegierten Werkstoffen
angepasste Geometrie und
Schneidkantenpräparation

perfekte Kühlschmierung
durch maximalen
Kühlkanalquerschnitt

sehr glatte, verschleißfeste
AlTiN nano-Beschichtung für
optimale Ergebnisse in rost- und
säurebeständigen Stählen

offenes Nutprofil für
perfekte Spanabfuhr auch in
langspanenden Werkstoffen

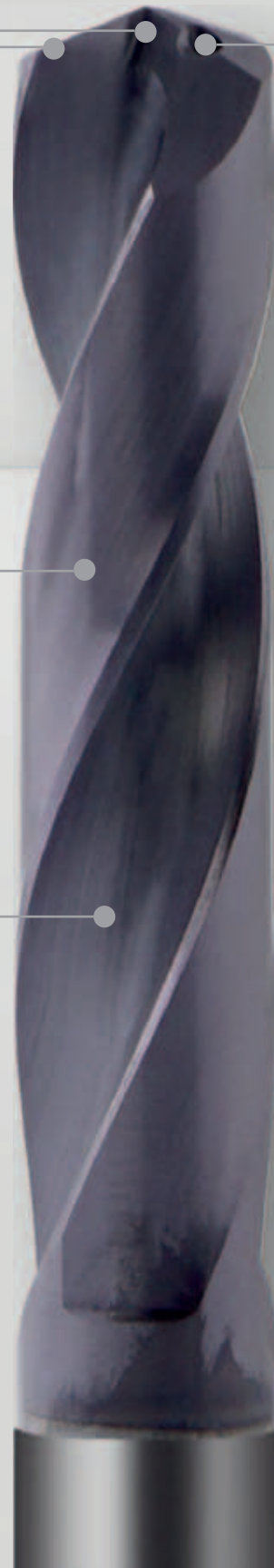



TS-Drills mit Innenkühlung

Artikel-Nr. 89450



P	M	K	N	S	H
○	●			○	

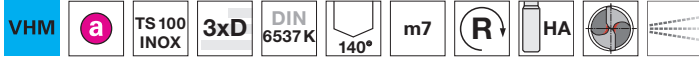

Ausspitzung $\geq \varnothing 3,000$ • Flächenanschliff • Hauptschneidenform gerade • optimierte Schneidengeometrie
rost-/säure-/hitzebeständige Stähle • Titan und Titanlegierungen • Inconel, Hastelloy, Monel

Artikel-Nr. 89550



P	M	K	N	S	H
○	●			○	

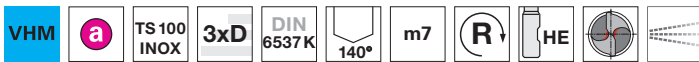

Ausspitzung $\geq \varnothing 3,000$ • Flächenanschliff • Hauptschneidenform gerade • optimierte Schneidengeometrie
rost-/säure-/hitzebeständige Stähle • Titan und Titanlegierungen • Inconel, Hastelloy, Monel

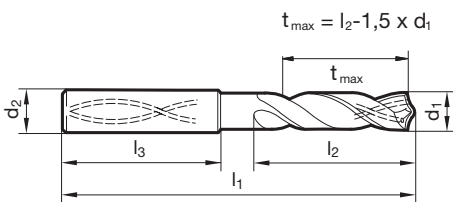

d1	inch	d2 h6	l1	l2	l3	d1	inch	d2 h6	l1	l2	l3
mm		mm	mm	mm	mm	mm		mm	mm	mm	mm
3,000		6,000	62,000	20,000	36,000	5,200		6,000	66,000	28,000	36,000
3,100		6,000	62,000	20,000	36,000	5,300		6,000	66,000	28,000	36,000
3,170	1/8	6,000	62,000	20,000	36,000	5,400		6,000	66,000	28,000	36,000
3,200		6,000	62,000	20,000	36,000	5,500		6,000	66,000	28,000	36,000
3,250		6,000	62,000	20,000	36,000	5,550		6,000	66,000	28,000	36,000
3,300		6,000	62,000	20,000	36,000	5,560	7/32	6,000	66,000	28,000	36,000
3,400		6,000	62,000	20,000	36,000	5,600		6,000	66,000	28,000	36,000
3,500		6,000	62,000	20,000	36,000	5,700		6,000	66,000	28,000	36,000
3,570	9/64	6,000	62,000	20,000	36,000	5,800		6,000	66,000	28,000	36,000
3,600		6,000	62,000	20,000	36,000	5,900		6,000	66,000	28,000	36,000
3,700		6,000	62,000	20,000	36,000	5,950	15/64	6,000	66,000	28,000	36,000
3,800		6,000	66,000	24,000	36,000	6,000		6,000	66,000	28,000	36,000
3,900		6,000	66,000	24,000	36,000	6,100		8,000	79,000	34,000	36,000
3,970	5/32	6,000	66,000	24,000	36,000	6,200		8,000	79,000	34,000	36,000
4,000		6,000	66,000	24,000	36,000	6,300		8,000	79,000	34,000	36,000
4,100		6,000	66,000	24,000	36,000	6,350	1/4	8,000	79,000	34,000	36,000
4,200		6,000	66,000	24,000	36,000	6,400		8,000	79,000	34,000	36,000
4,300		6,000	66,000	24,000	36,000	6,500		8,000	79,000	34,000	36,000
4,370	11/64	6,000	66,000	24,000	36,000	6,600		8,000	79,000	34,000	36,000
4,400		6,000	66,000	24,000	36,000	6,700		8,000	79,000	34,000	36,000
4,500		6,000	66,000	24,000	36,000	6,750	17/64	8,000	79,000	34,000	36,000
4,600		6,000	66,000	24,000	36,000	6,800		8,000	79,000	34,000	36,000
4,650		6,000	66,000	24,000	36,000	6,900		8,000	79,000	34,000	36,000
4,700		6,000	66,000	24,000	36,000	7,000		8,000	79,000	34,000	36,000
4,760	3/16	6,000	66,000	28,000	36,000	7,100		8,000	79,000	41,000	36,000
4,800		6,000	66,000	28,000	36,000	7,140	9/32	8,000	79,000	41,000	36,000
4,900		6,000	66,000	28,000	36,000	7,200		8,000	79,000	41,000	36,000
5,000		6,000	66,000	28,000	36,000	7,300		8,000	79,000	41,000	36,000
5,100		6,000	66,000	28,000	36,000	7,400		8,000	79,000	41,000	36,000
5,160	13/64	6,000	66,000	28,000	36,000	7,500		8,000	79,000	41,000	36,000



TS-Drills mit Innenkühlung

d1 mm	inch	d2 h6 mm	l1 mm	l2 mm	l3 mm	d1 mm	inch	d2 h6 mm	l1 mm	l2 mm	l3 mm
7,540	19/64	8,000	79,000	41,000	36,000	10,900		12,000	102,000	55,000	45,000
7,600		8,000	79,000	41,000	36,000	11,000		12,000	102,000	55,000	45,000
7,700		8,000	79,000	41,000	36,000	11,100		12,000	102,000	55,000	45,000
7,800		8,000	79,000	41,000	36,000	11,110	7/16	12,000	102,000	55,000	45,000
7,900		8,000	79,000	41,000	36,000	11,200		12,000	102,000	55,000	45,000
7,940	5/16	8,000	79,000	41,000	36,000	11,300		12,000	102,000	55,000	45,000
8,000		8,000	79,000	41,000	36,000	11,400		12,000	102,000	55,000	45,000
8,100		10,000	89,000	47,000	40,000	11,500		12,000	102,000	55,000	45,000
8,200		10,000	89,000	47,000	40,000	11,600		12,000	102,000	55,000	45,000
8,300		10,000	89,000	47,000	40,000	11,700		12,000	102,000	55,000	45,000
8,330	21/64	10,000	89,000	47,000	40,000	11,800		12,000	102,000	55,000	45,000
8,400		10,000	89,000	47,000	40,000	11,900		12,000	102,000	55,000	45,000
8,500		10,000	89,000	47,000	40,000	11,910	15/32	12,000	102,000	55,000	45,000
8,600		10,000	89,000	47,000	40,000	12,000		12,000	102,000	55,000	45,000
8,700		10,000	89,000	47,000	40,000	12,200		14,000	107,000	60,000	45,000
8,730	11/32	10,000	89,000	47,000	40,000	12,500		14,000	107,000	60,000	45,000
8,800		10,000	89,000	47,000	40,000	12,700	1/2	14,000	107,000	60,000	45,000
8,900		10,000	89,000	47,000	40,000	13,000		14,000	107,000	60,000	45,000
9,000		10,000	89,000	47,000	40,000	13,500		14,000	107,000	60,000	45,000
9,100		10,000	89,000	47,000	40,000	13,700		14,000	107,000	60,000	45,000
9,130	23/64	10,000	89,000	47,000	40,000	14,000		14,000	107,000	60,000	45,000
9,200		10,000	89,000	47,000	40,000	14,200		16,000	115,000	65,000	48,000
9,250		10,000	89,000	47,000	40,000	14,290	9/16	16,000	115,000	65,000	48,000
9,300		10,000	89,000	47,000	40,000	14,500		16,000	115,000	65,000	48,000
9,400		10,000	89,000	47,000	40,000	14,700		16,000	115,000	65,000	48,000
9,500		10,000	89,000	47,000	40,000	15,000		16,000	115,000	65,000	48,000
9,520	3/8	10,000	89,000	47,000	40,000	15,200		16,000	115,000	65,000	48,000
9,600		10,000	89,000	47,000	40,000	15,500		16,000	115,000	65,000	48,000
9,700		10,000	89,000	47,000	40,000	15,700		16,000	115,000	65,000	48,000
9,800		10,000	89,000	47,000	40,000	16,000		16,000	115,000	65,000	48,000
9,900		10,000	89,000	47,000	40,000	16,500		18,000	123,000	73,000	48,000
9,920	25/64	10,000	89,000	47,000	40,000	17,000		18,000	123,000	73,000	48,000
10,000		10,000	89,000	47,000	40,000	17,500		18,000	123,000	73,000	48,000
10,100		12,000	102,000	55,000	45,000	18,000		18,000	123,000	73,000	48,000
10,200		12,000	102,000	55,000	45,000	18,500		20,000	131,000	79,000	50,000
10,300		12,000	102,000	55,000	45,000	19,000		20,000	131,000	79,000	50,000
10,320	13/32	12,000	102,000	55,000	45,000	19,500		20,000	131,000	79,000	50,000
10,400		12,000	102,000	55,000	45,000	20,000		20,000	131,000	79,000	50,000
10,500		12,000	102,000	55,000	45,000						
10,600		12,000	102,000	55,000	45,000						
10,700		12,000	102,000	55,000	45,000						
10,800		12,000	102,000	55,000	45,000						

TS 100 INOX



TS-Drills mit Innenkühlung

Artikel-Nr. 89451



P	M	K	N	S	H
○	●			○	

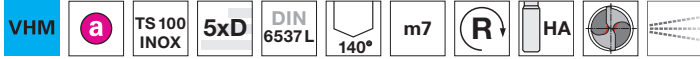

Ausspitzung $\geq \varnothing 3,000$ • Flächenanschliff • Hauptschneidenform gerade • optimierte Schneidengeometrie
rost-/säure-/hitzebeständige Stähle • Titan und Titanlegierungen • Inconel, Hastelloy, Monel

Artikel-Nr. 89551



P	M	K	N	S	H
○	●			○	



Ausspitzung $\geq \varnothing 3,000$ • Flächenanschliff • Hauptschneidenform gerade • optimierte Schneidengeometrie
rost-/säure-/hitzebeständige Stähle • Titan und Titanlegierungen • Inconel, Hastelloy, Monel

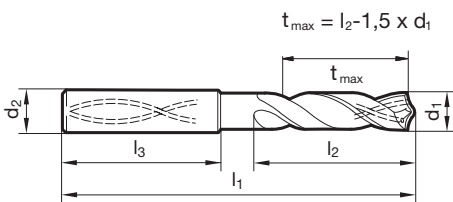

d1	inch	d2 h6	l1	l2	l3	d1	inch	d2 h6	l1	l2	l3
mm		mm	mm	mm	mm	mm		mm	mm	mm	mm
3,000		6,000	66,000	28,000	36,000	5,200		6,000	82,000	44,000	36,000
3,100		6,000	66,000	28,000	36,000	5,300		6,000	82,000	44,000	36,000
3,170	1/8	6,000	66,000	28,000	36,000	5,400		6,000	82,000	44,000	36,000
3,200		6,000	66,000	28,000	36,000	5,500		6,000	82,000	44,000	36,000
3,250		6,000	66,000	28,000	36,000	5,550		6,000	82,000	44,000	36,000
3,300		6,000	66,000	28,000	36,000	5,560	7/32	6,000	82,000	44,000	36,000
3,400		6,000	66,000	28,000	36,000	5,600		6,000	82,000	44,000	36,000
3,500		6,000	66,000	28,000	36,000	5,700		6,000	82,000	44,000	36,000
3,570	9/64	6,000	66,000	28,000	36,000	5,800		6,000	82,000	44,000	36,000
3,600		6,000	66,000	28,000	36,000	5,900		6,000	82,000	44,000	36,000
3,700		6,000	66,000	28,000	36,000	5,950	15/64	6,000	82,000	44,000	36,000
3,800		6,000	74,000	36,000	36,000	6,000		6,000	82,000	44,000	36,000
3,900		6,000	74,000	36,000	36,000	6,100		8,000	91,000	53,000	36,000
3,970	5/32	6,000	74,000	36,000	36,000	6,200		8,000	91,000	53,000	36,000
4,000		6,000	74,000	36,000	36,000	6,300		8,000	91,000	53,000	36,000
4,100		6,000	74,000	36,000	36,000	6,350	1/4	8,000	91,000	53,000	36,000
4,200		6,000	74,000	36,000	36,000	6,400		8,000	91,000	53,000	36,000
4,300		6,000	74,000	36,000	36,000	6,500		8,000	91,000	53,000	36,000
4,370	11/64	6,000	74,000	36,000	36,000	6,600		8,000	91,000	53,000	36,000
4,400		6,000	74,000	36,000	36,000	6,700		8,000	91,000	53,000	36,000
4,500		6,000	74,000	36,000	36,000	6,750	17/64	8,000	91,000	53,000	36,000
4,600		6,000	74,000	36,000	36,000	6,800		8,000	91,000	53,000	36,000
4,650		6,000	74,000	36,000	36,000	6,900		8,000	91,000	53,000	36,000
4,700		6,000	74,000	36,000	36,000	7,000		8,000	91,000	53,000	36,000
4,760	3/16	6,000	82,000	44,000	36,000	7,100		8,000	91,000	53,000	36,000
4,800		6,000	82,000	44,000	36,000	7,140	9/32	8,000	91,000	53,000	36,000
4,900		6,000	82,000	44,000	36,000	7,200		8,000	91,000	53,000	36,000
5,000		6,000	82,000	44,000	36,000	7,300		8,000	91,000	53,000	36,000
5,100		6,000	82,000	44,000	36,000	7,400		8,000	91,000	53,000	36,000
5,160	13/64	6,000	82,000	44,000	36,000	7,500		8,000	91,000	53,000	36,000



TS-Drills mit Innenkühlung

d1 mm	inch	d2 h6 mm	l1 mm	l2 mm	l3 mm	d1 mm	inch	d2 h6 mm	l1 mm	l2 mm	l3 mm
7,540	19/64	8,000	91,000	53,000	36,000	10,900		12,000	118,000	71,000	45,000
7,600		8,000	91,000	53,000	36,000	11,000		12,000	118,000	71,000	45,000
7,700		8,000	91,000	53,000	36,000	11,100		12,000	118,000	71,000	45,000
7,800		8,000	91,000	53,000	36,000	11,110	7/16	12,000	118,000	71,000	45,000
7,900		8,000	91,000	53,000	36,000	11,200		12,000	118,000	71,000	45,000
7,940	5/16	8,000	91,000	53,000	36,000	11,300		12,000	118,000	71,000	45,000
8,000		8,000	91,000	53,000	36,000	11,400		12,000	118,000	71,000	45,000
8,100		10,000	103,000	61,000	40,000	11,500		12,000	118,000	71,000	45,000
8,200		10,000	103,000	61,000	40,000	11,600		12,000	118,000	71,000	45,000
8,300		10,000	103,000	61,000	40,000	11,700		12,000	118,000	71,000	45,000
8,330	21/64	10,000	103,000	61,000	40,000	11,800		12,000	118,000	71,000	45,000
8,400		10,000	103,000	61,000	40,000	11,900		12,000	118,000	71,000	45,000
8,500		10,000	103,000	61,000	40,000	11,910	15/32	12,000	118,000	71,000	45,000
8,600		10,000	103,000	61,000	40,000	12,000		12,000	118,000	71,000	45,000
8,700		10,000	103,000	61,000	40,000	12,200		14,000	124,000	77,000	45,000
8,730	11/32	10,000	103,000	61,000	40,000	12,500		14,000	124,000	77,000	45,000
8,800		10,000	103,000	61,000	40,000	12,700	1/2	14,000	124,000	77,000	45,000
8,900		10,000	103,000	61,000	40,000	13,000		14,000	124,000	77,000	45,000
9,000		10,000	103,000	61,000	40,000	13,500		14,000	124,000	77,000	45,000
9,100		10,000	103,000	61,000	40,000	13,700		14,000	124,000	77,000	45,000
9,130	23/64	10,000	103,000	61,000	40,000	14,000		14,000	124,000	77,000	45,000
9,200		10,000	103,000	61,000	40,000	14,200		16,000	133,000	83,000	48,000
9,250		10,000	103,000	61,000	40,000	14,290	9/16	16,000	133,000	83,000	48,000
9,300		10,000	103,000	61,000	40,000	14,500		16,000	133,000	83,000	48,000
9,400		10,000	103,000	61,000	40,000	14,700		16,000	133,000	83,000	48,000
9,500		10,000	103,000	61,000	40,000	15,000		16,000	133,000	83,000	48,000
9,520	3/8	10,000	103,000	61,000	40,000	15,200		16,000	133,000	83,000	48,000
9,600		10,000	103,000	61,000	40,000	15,500		16,000	133,000	83,000	48,000
9,700		10,000	103,000	61,000	40,000	15,700		16,000	133,000	83,000	48,000
9,800		10,000	103,000	61,000	40,000	16,000		16,000	133,000	83,000	48,000
9,900		10,000	103,000	61,000	40,000	16,500		18,000	143,000	93,000	48,000
9,920	25/64	10,000	103,000	61,000	40,000	17,000		18,000	143,000	93,000	48,000
10,000		10,000	103,000	61,000	40,000	17,500		18,000	143,000	93,000	48,000
10,100		12,000	118,000	71,000	45,000	18,000		18,000	143,000	93,000	48,000
10,200		12,000	118,000	71,000	45,000	18,500		20,000	153,000	101,000	50,000
10,300		12,000	118,000	71,000	45,000	19,000		20,000	153,000	101,000	50,000
10,320	13/32	12,000	118,000	71,000	45,000	19,500		20,000	153,000	101,000	50,000
10,400		12,000	118,000	71,000	45,000	20,000		20,000	153,000	101,000	50,000
10,500		12,000	118,000	71,000	45,000						
10,600		12,000	118,000	71,000	45,000						
10,700		12,000	118,000	71,000	45,000						
10,800		12,000	118,000	71,000	45,000						

TS 100 INOX

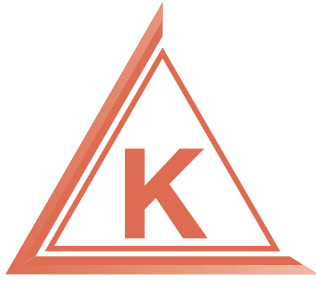

TS 100 R

▼ VORTEILE UND EIGENSCHAFTEN

- ▼ **Spezialgeometrie** mit patentiertem Radiananschliff sorgt für **höchste Leistungsfähigkeit** und Wirtschaftlichkeit bei der Bearbeitung von GGV (Gusseisen mit Vermikulargraphit) und ADI (Austempered Ductile Iron) sowie allen herkömmlichen Gusswerkstoffen
- ▼ durch die einzigartige Abstimmung von Stirnkontur und Nutprofil arbeitet der TS 100 R **äußerst stabil**, maßhaltig und **prozesssicher**
- ▼ geeignet für **Bohrtiefen $\leq 7 \times D$**



GRAU-, TEMPER- UND SPHÄROGUSS, GGV/ADI/CDI

erhebliche Verschleißreduzierung durch **patentierten Radienanschliff**

stabiler Spitzenanschliff mit Spezialauspitzung garantiert exaktes Anbohren und maßhaltige Bohrungen

nanoFIRE-Beschichtung für höchste Verschleißfestigkeit in abrasiven Gusswerkstoffen

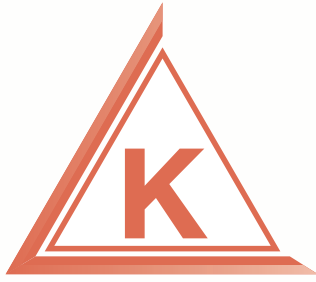

TS 150 GG

▼ VORTEILE UND EIGENSCHAFTEN

- ▼ **leistungsstarker VHM-Bohrer** mit Kühlkanälen für die Bearbeitung von **kurzspanenden Werkstoffen** wie Gusseisen, Grauguss, Temper- und Kugelgraphitguss
- ▼ zur Herstellung von **Bohrungen** mit **extrem hoher Fluchtungsgenauigkeit**
- ▼ auf Wunsch auch **mit Beschichtungen** lieferbar



GRAU-, TEMPER- UND SPHÄROGUSS

speziell angepasste
Schneidengeometrie für die
wirtschaftliche Bearbeitung von
nahezu allen Gusswerkstoffen

blanke Ausführung für
optimale Spanabfuhr

Spezialausspitzung für
exaktes Anbohren und
geringen Mittenverlauf

vier Führungsfasen sichern
die Geradheit und Rundheit
der Bohrung



TS-Drills mit Innenkühlung

Artikel-Nr. 89420



P	M	K	N	S	H
		•			

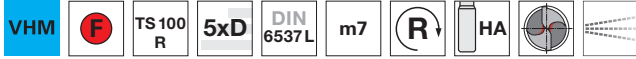

Ausspitzung $\geq \text{Ø } 3,000$ • patentierter Radienanschliff • Schneidenform gerade (durch Korrektur)
 Vermikularguss GGv und ADI, CDI • Grauguss, Temperguss, Sphäroguss

TS 100 R | TS 150 GG

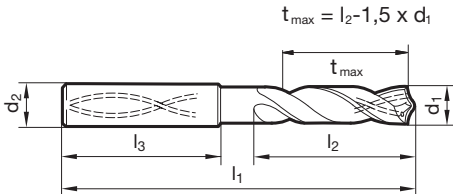

d1		d2 h6	l1	l2	l3	d1		d2 h6	l1	l2	l3
mm	inch	mm	mm	mm	mm	mm	inch	mm	mm	mm	mm
3,000		6,000	66,000	28,000	36,000	6,100		8,000	91,000	53,000	36,000
3,100		6,000	66,000	28,000	36,000	6,200		8,000	91,000	53,000	36,000
3,170	1/8	6,000	66,000	28,000	36,000	6,300		8,000	91,000	53,000	36,000
3,200		6,000	66,000	28,000	36,000	6,350	1/4	8,000	91,000	53,000	36,000
3,250		6,000	66,000	28,000	36,000	6,400		8,000	91,000	53,000	36,000
3,300		6,000	66,000	28,000	36,000	6,500		8,000	91,000	53,000	36,000
3,400		6,000	66,000	28,000	36,000	6,600		8,000	91,000	53,000	36,000
3,500		6,000	66,000	28,000	36,000	6,700		8,000	91,000	53,000	36,000
3,570	9/64	6,000	66,000	28,000	36,000	6,750	17/64	8,000	91,000	53,000	36,000
3,600		6,000	66,000	28,000	36,000	6,800		8,000	91,000	53,000	36,000
3,700		6,000	66,000	28,000	36,000	6,900		8,000	91,000	53,000	36,000
3,800		6,000	74,000	36,000	36,000	7,000		8,000	91,000	53,000	36,000
3,900		6,000	74,000	36,000	36,000	7,100		8,000	91,000	53,000	36,000
3,970	5/32	6,000	74,000	36,000	36,000	7,140	9/32	8,000	91,000	53,000	36,000
4,000		6,000	74,000	36,000	36,000	7,200		8,000	91,000	53,000	36,000
4,100		6,000	74,000	36,000	36,000	7,300		8,000	91,000	53,000	36,000
4,200		6,000	74,000	36,000	36,000	7,400		8,000	91,000	53,000	36,000
4,300		6,000	74,000	36,000	36,000	7,500		8,000	91,000	53,000	36,000
4,370	11/64	6,000	74,000	36,000	36,000	7,540	19/64	8,000	91,000	53,000	36,000
4,400		6,000	74,000	36,000	36,000	7,600		8,000	91,000	53,000	36,000
4,500		6,000	74,000	36,000	36,000	7,700		8,000	91,000	53,000	36,000
4,600		6,000	74,000	36,000	36,000	7,800		8,000	91,000	53,000	36,000
4,650		6,000	74,000	36,000	36,000	7,900		8,000	91,000	53,000	36,000
4,700		6,000	74,000	36,000	36,000	7,940	5/16	8,000	91,000	53,000	36,000
4,760	3/16	6,000	82,000	44,000	36,000	8,000		8,000	91,000	53,000	36,000
4,800		6,000	82,000	44,000	36,000	8,100		10,000	103,000	61,000	40,000
4,900		6,000	82,000	44,000	36,000	8,200		10,000	103,000	61,000	40,000
5,000		6,000	82,000	44,000	36,000	8,300		10,000	103,000	61,000	40,000
5,100		6,000	82,000	44,000	36,000	8,330	21/64	10,000	103,000	61,000	40,000
5,160	13/64	6,000	82,000	44,000	36,000	8,400		10,000	103,000	61,000	40,000
5,200		6,000	82,000	44,000	36,000	8,500		10,000	103,000	61,000	40,000
5,300		6,000	82,000	44,000	36,000	8,600		10,000	103,000	61,000	40,000
5,400		6,000	82,000	44,000	36,000	8,700		10,000	103,000	61,000	40,000
5,500		6,000	82,000	44,000	36,000	8,730	11/32	10,000	103,000	61,000	40,000
5,550		6,000	82,000	44,000	36,000	8,800		10,000	103,000	61,000	40,000
5,560	7/32	6,000	82,000	44,000	36,000	8,900		10,000	103,000	61,000	40,000
5,600		6,000	82,000	44,000	36,000	9,000		10,000	103,000	61,000	40,000
5,700		6,000	82,000	44,000	36,000	9,100		10,000	103,000	61,000	40,000
5,800		6,000	82,000	44,000	36,000	9,130	23/64	10,000	103,000	61,000	40,000
5,900		6,000	82,000	44,000	36,000	9,200		10,000	103,000	61,000	40,000
5,950	15/64	6,000	82,000	44,000	36,000	9,250		10,000	103,000	61,000	40,000
6,000		6,000	82,000	44,000	36,000	9,300		10,000	103,000	61,000	40,000



TS-Drills mit Innenkühlung

d1 mm	inch	d2 h6 mm	l1 mm	l2 mm	l3 mm	d1 mm	inch	d2 h6 mm	l1 mm	l2 mm	l3 mm
9,400		10,000	103,000	61,000	40,000	13,000		14,000	124,000	77,000	45,000
9,500		10,000	103,000	61,000	40,000	13,100	33/64	14,000	124,000	77,000	45,000
9,520	3/8	10,000	103,000	61,000	40,000	13,300		14,000	124,000	77,000	45,000
9,600		10,000	103,000	61,000	40,000	13,400		14,000	124,000	77,000	45,000
9,700		10,000	103,000	61,000	40,000	13,500		14,000	124,000	77,000	45,000
9,800		10,000	103,000	61,000	40,000	13,700		14,000	124,000	77,000	45,000
9,900		10,000	103,000	61,000	40,000	13,800		14,000	124,000	77,000	45,000
9,920	25/64	10,000	103,000	61,000	40,000	13,900		14,000	124,000	77,000	45,000
10,000		10,000	103,000	61,000	40,000	14,000		14,000	124,000	77,000	45,000
10,100		12,000	118,000	71,000	45,000	14,100		16,000	133,000	83,000	48,000
10,200		12,000	118,000	71,000	45,000	14,200		16,000	133,000	83,000	48,000
10,300		12,000	118,000	71,000	45,000	14,290	9/16	16,000	133,000	83,000	48,000
10,320	13/32	12,000	118,000	71,000	45,000	14,300		16,000	133,000	83,000	48,000
10,400		12,000	118,000	71,000	45,000	14,400		16,000	133,000	83,000	48,000
10,500		12,000	118,000	71,000	45,000	14,500		16,000	133,000	83,000	48,000
10,600		12,000	118,000	71,000	45,000	14,600		16,000	133,000	83,000	48,000
10,700		12,000	118,000	71,000	45,000	14,700		16,000	133,000	83,000	48,000
10,720	27/64	12,000	118,000	71,000	45,000	14,900		16,000	133,000	83,000	48,000
10,800		12,000	118,000	71,000	45,000	15,000		16,000	133,000	83,000	48,000
10,900		12,000	118,000	71,000	45,000	15,100		16,000	133,000	83,000	48,000
11,000		12,000	118,000	71,000	45,000	15,200		16,000	133,000	83,000	48,000
11,100		12,000	118,000	71,000	45,000	15,300		16,000	133,000	83,000	48,000
11,110	7/16	12,000	118,000	71,000	45,000	15,400		16,000	133,000	83,000	48,000
11,200		12,000	118,000	71,000	45,000	15,500		16,000	133,000	83,000	48,000
11,300		12,000	118,000	71,000	45,000	15,600		16,000	133,000	83,000	48,000
11,400		12,000	118,000	71,000	45,000	15,700		16,000	133,000	83,000	48,000
11,500		12,000	118,000	71,000	45,000	15,800		16,000	133,000	83,000	48,000
11,600		12,000	118,000	71,000	45,000	15,870	5/8	16,000	133,000	83,000	48,000
11,700		12,000	118,000	71,000	45,000	15,900		16,000	133,000	83,000	48,000
11,800		12,000	118,000	71,000	45,000	16,000		16,000	133,000	83,000	48,000
11,900		12,000	118,000	71,000	45,000	16,500		18,000	143,000	93,000	48,000
11,910	15/32	12,000	118,000	71,000	45,000	16,670	21/32	18,000	143,000	93,000	48,000
12,000		12,000	118,000	71,000	45,000	17,000		18,000	143,000	93,000	48,000
12,100		14,000	124,000	77,000	45,000	17,500		18,000	143,000	93,000	48,000
12,200		14,000	124,000	77,000	45,000	18,000		18,000	143,000	93,000	48,000
12,300	31/64	14,000	124,000	77,000	45,000	18,500		20,000	153,000	101,000	50,000
12,400		14,000	124,000	77,000	45,000	19,000		20,000	153,000	101,000	50,000
12,500		14,000	124,000	77,000	45,000	19,500		20,000	153,000	101,000	50,000
12,600		14,000	124,000	77,000	45,000	20,000		20,000	153,000	101,000	50,000
12,700	1/2	14,000	124,000	77,000	45,000						
12,800		14,000	124,000	77,000	45,000						
12,900		14,000	124,000	77,000	45,000						

TS 100 R | TS 150 GG



TS-Drills mit Innenkühlung

Artikel-Nr. 89421



P	M	K	N	S	H
		•			



Ausspitzung $\geq \text{Ø } 4,000$ • patentierter Radienanschliff • Schneidenform gerade (durch Korrektur)
 Vermikularguss GGv und ADI, CDI • Grauguss, Temperguss, Sphäroguss

TS 100 R | TS 150 GG

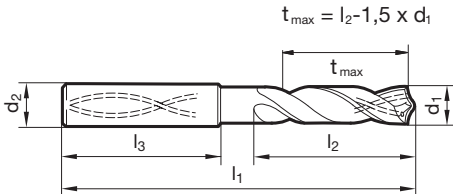

d1		d2 h6	l1	l2	l3	d1		d2 h6	l1	l2	l3
mm	inch	mm	mm	mm	mm	mm	inch	mm	mm	mm	mm
4,000		6,000	75,000	37,500	36,000	7,200		8,000	116,000	76,000	36,000
4,100		6,000	75,000	37,500	36,000	7,300		8,000	116,000	76,000	36,000
4,200		6,000	75,000	37,500	36,000	7,400		8,000	116,000	76,000	36,000
4,300		6,000	85,000	45,000	36,000	7,500		8,000	116,000	76,000	36,000
4,370	11/64	6,000	85,000	45,000	36,000	7,540	19/64	8,000	116,000	76,000	36,000
4,400		6,000	85,000	45,000	36,000	7,600		8,000	116,000	76,000	36,000
4,500		6,000	85,000	45,000	36,000	7,700		8,000	116,000	76,000	36,000
4,600		6,000	85,000	45,000	36,000	7,800		8,000	116,000	76,000	36,000
4,650		6,000	85,000	45,000	36,000	7,900		8,000	116,000	76,000	36,000
4,700		6,000	85,000	45,000	36,000	7,940	5/16	8,000	116,000	76,000	36,000
4,760	3/16	6,000	90,000	50,000	36,000	8,000		8,000	116,000	76,000	36,000
4,800		6,000	90,000	50,000	36,000	8,100		10,000	131,000	87,000	40,000
4,900		6,000	90,000	50,000	36,000	8,200		10,000	131,000	87,000	40,000
5,000		6,000	90,000	50,000	36,000	8,300		10,000	131,000	87,000	40,000
5,100		6,000	90,000	50,000	36,000	8,330	21/64	10,000	131,000	87,000	40,000
5,160	13/64	6,000	90,000	50,000	36,000	8,400		10,000	131,000	87,000	40,000
5,200		6,000	90,000	50,000	36,000	8,500		10,000	131,000	87,000	40,000
5,300		6,000	90,000	50,000	36,000	8,600		10,000	131,000	87,000	40,000
5,400		6,000	97,000	57,000	36,000	8,700		10,000	131,000	87,000	40,000
5,500		6,000	97,000	57,000	36,000	8,730	11/32	10,000	131,000	87,000	40,000
5,550		6,000	97,000	57,000	36,000	8,800		10,000	131,000	87,000	40,000
5,560	7/32	6,000	97,000	57,000	36,000	8,900		10,000	131,000	87,000	40,000
5,600		6,000	97,000	57,000	36,000	9,000		10,000	131,000	87,000	40,000
5,700		6,000	97,000	57,000	36,000	9,100		10,000	139,000	95,000	40,000
5,800		6,000	97,000	57,000	36,000	9,130	23/64	10,000	139,000	95,000	40,000
5,900		6,000	97,000	57,000	36,000	9,200		10,000	139,000	95,000	40,000
5,950	15/64	6,000	97,000	57,000	36,000	9,250		10,000	139,000	95,000	40,000
6,000		6,000	97,000	57,000	36,000	9,300		10,000	139,000	95,000	40,000
6,100		8,000	106,000	66,000	36,000	9,400		10,000	139,000	95,000	40,000
6,200		8,000	106,000	66,000	36,000	9,500		10,000	139,000	95,000	40,000
6,300		8,000	106,000	66,000	36,000	9,520	3/8	10,000	139,000	95,000	40,000
6,350	1/4	8,000	106,000	66,000	36,000	9,600		10,000	139,000	95,000	40,000
6,400		8,000	106,000	66,000	36,000	9,700		10,000	139,000	95,000	40,000
6,500		8,000	106,000	66,000	36,000	9,800		10,000	139,000	95,000	40,000
6,600		8,000	106,000	66,000	36,000	9,900		10,000	139,000	95,000	40,000
6,700		8,000	106,000	66,000	36,000	9,920	25/64	10,000	139,000	95,000	40,000
6,750	17/64	8,000	106,000	66,000	36,000	10,000		10,000	139,000	95,000	40,000
6,800		8,000	106,000	66,000	36,000	10,100		12,000	155,000	106,000	45,000
6,900		8,000	116,000	76,000	36,000	10,200		12,000	155,000	106,000	45,000
7,000		8,000	116,000	76,000	36,000	10,300		12,000	155,000	106,000	45,000
7,100		8,000	116,000	76,000	36,000	10,320	13/32	12,000	155,000	106,000	45,000
7,140	9/32	8,000	116,000	76,000	36,000	10,400		12,000	155,000	106,000	45,000



TS-Drills mit Innenkühlung

d1 mm	inch	d2 h6 mm	l1 mm	l2 mm	l3 mm	d1 mm	inch	d2 h6 mm	l1 mm	l2 mm	l3 mm
10,500		12,000	155,000	106,000	45,000	14,000		14,000	182,000	133,000	45,000
10,600		12,000	155,000	106,000	45,000	14,100		16,000	204,000	152,000	48,000
10,700		12,000	155,000	106,000	45,000	14,200		16,000	204,000	152,000	48,000
10,720	27/64	12,000	155,000	106,000	45,000	14,290	9/16	16,000	204,000	152,000	48,000
10,800		12,000	155,000	106,000	45,000	14,300		16,000	204,000	152,000	48,000
10,900		12,000	155,000	106,000	45,000	14,400		16,000	204,000	152,000	48,000
11,000		12,000	155,000	106,000	45,000	14,500		16,000	204,000	152,000	48,000
11,100		12,000	163,000	114,000	45,000	14,600		16,000	204,000	152,000	48,000
11,110	7/16	12,000	163,000	114,000	45,000	14,700		16,000	204,000	152,000	48,000
11,200		12,000	163,000	114,000	45,000	14,900		16,000	204,000	152,000	48,000
11,300		12,000	163,000	114,000	45,000	15,000		16,000	204,000	152,000	48,000
11,400		12,000	163,000	114,000	45,000	15,100		16,000	204,000	152,000	48,000
11,500		12,000	163,000	114,000	45,000	15,200		16,000	204,000	152,000	48,000
11,600		12,000	163,000	114,000	45,000	15,300		16,000	204,000	152,000	48,000
11,700		12,000	163,000	114,000	45,000	15,400		16,000	204,000	152,000	48,000
11,800		12,000	163,000	114,000	45,000	15,500		16,000	204,000	152,000	48,000
11,900		12,000	163,000	114,000	45,000	15,600		16,000	204,000	152,000	48,000
11,910	15/32	12,000	163,000	114,000	45,000	15,700		16,000	204,000	152,000	48,000
12,000		12,000	163,000	114,000	45,000	15,800		16,000	204,000	152,000	48,000
12,100		14,000	182,000	133,000	45,000	15,870	5/8	16,000	204,000	152,000	48,000
12,200		14,000	182,000	133,000	45,000	15,900		16,000	204,000	152,000	48,000
12,300	31/64	14,000	182,000	133,000	45,000	16,000		16,000	204,000	152,000	48,000
12,400		14,000	182,000	133,000	45,000	16,500		18,000	223,000	171,000	48,000
12,500		14,000	182,000	133,000	45,000	16,670	21/32	18,000	223,000	171,000	48,000
12,600		14,000	182,000	133,000	45,000	17,000		18,000	223,000	171,000	48,000
12,700	1/2	14,000	182,000	133,000	45,000	17,500		18,000	223,000	171,000	48,000
12,800		14,000	182,000	133,000	45,000	18,000		18,000	223,000	171,000	48,000
12,900		14,000	182,000	133,000	45,000	18,500		20,000	244,000	190,000	50,000
13,000		14,000	182,000	133,000	45,000	19,000		20,000	244,000	190,000	50,000
13,100	33/64	14,000	182,000	133,000	45,000	19,500		20,000	244,000	190,000	50,000
13,300		14,000	182,000	133,000	45,000	20,000		20,000	244,000	190,000	50,000
13,400		14,000	182,000	133,000	45,000						
13,500		14,000	182,000	133,000	45,000						
13,700		14,000	182,000	133,000	45,000						
13,800		14,000	182,000	133,000	45,000						
13,900		14,000	182,000	133,000	45,000						

TS 100 R | TS 150 GG



TS-Drills mit Innenkühlung

Artikel-Nr. 89292



P	M	K	N	S	H
		•	○		

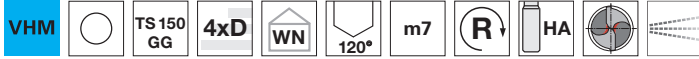

Ausspitzung $\geq \varnothing 3,000$ • Flächenanschliff • enge Durchmessertoleranzen • sehr gute Bohrungsoberflächen • Kühlmitteldruck beachten
 Grauguss, Temperguss, Sphäroguss

TS 100 R | TS 150 GG

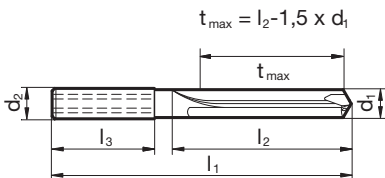

d1	inch	d2 h6	l1	l2	l3	d1	inch	d2 h6	l1	l2	l3
mm		mm	mm	mm	mm	mm		mm	mm	mm	mm
3,000		6,000	66,000	24,000	36,000	8,300		10,000	103,000	61,000	40,000
3,100		6,000	66,000	24,000	36,000	8,400		10,000	103,000	61,000	40,000
3,200		6,000	66,000	24,000	36,000	8,500		10,000	103,000	61,000	40,000
3,300		6,000	66,000	24,000	36,000	8,700		10,000	103,000	61,000	40,000
3,400		6,000	66,000	24,000	36,000	9,000		10,000	103,000	61,000	40,000
3,500		6,000	66,000	24,000	36,000	9,400		10,000	103,000	61,000	40,000
3,600		6,000	66,000	24,000	36,000	10,000		10,000	103,000	61,000	40,000
3,700		6,000	66,000	24,000	36,000	10,200		12,000	118,000	71,000	45,000
3,800		6,000	74,000	30,000	36,000	10,500		12,000	118,000	71,000	45,000
3,900		6,000	74,000	30,000	36,000	11,000		12,000	118,000	71,000	45,000
4,000		6,000	74,000	30,000	36,000	11,500		12,000	118,000	71,000	45,000
4,200		6,000	74,000	30,000	36,000	12,000		12,000	118,000	71,000	45,000
5,000		6,000	74,000	36,000	36,000	12,300	31/64	14,000	124,000	74,000	45,000
5,100		6,000	74,000	36,000	36,000	12,500		14,000	124,000	74,000	45,000
5,300		6,000	74,000	36,000	36,000	12,700	1/2	14,000	124,000	74,000	45,000
5,400		6,000	74,000	36,000	36,000	13,000		14,000	124,000	74,000	45,000
5,900		6,000	74,000	36,000	36,000	14,000		14,000	124,000	74,000	45,000
6,000		6,000	74,000	36,000	36,000	15,000		16,000	133,000	83,000	48,000
6,200		8,000	91,000	53,000	36,000	16,000		16,000	133,000	83,000	48,000
6,300		8,000	91,000	53,000	36,000	16,500		18,000	143,000	93,000	48,000
6,400		8,000	91,000	53,000	36,000	17,000		18,000	143,000	93,000	48,000
6,600		8,000	91,000	53,000	36,000	17,500		18,000	143,000	93,000	48,000
6,700		8,000	91,000	53,000	36,000	18,000		18,000	143,000	93,000	48,000
6,800		8,000	91,000	53,000	36,000	19,000		20,000	153,000	101,000	50,000
7,000		8,000	91,000	53,000	36,000	20,000		20,000	153,000	101,000	50,000
7,400		8,000	91,000	53,000	36,000						
7,500		8,000	91,000	53,000	36,000						
8,000		8,000	91,000	53,000	36,000						
8,100		10,000	103,000	61,000	40,000						
8,200		10,000	103,000	61,000	40,000						



TS-Drills mit Innenkühlung

Artikel-Nr. 89294



P	M	K	N	S	H
		•	○		

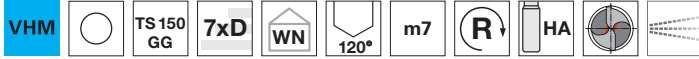

Ausspitzung $\geq \text{Ø } 3,000$ • Kegelmantelschliff • enge Durchmesser-toleranzen • sehr gute Bohrungs-oberflächen • optimalen Kühlmitteldruck beachten

Grauguss, Temperguss, Sphäroguss

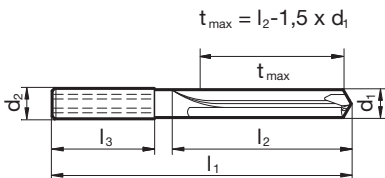

d1		d2 h6	l1	l2	l3	d1		d2 h6	l1	l2	l3
mm	inch	mm	mm	mm	mm	mm	inch	mm	mm	mm	mm
3,000		6,000	74,000	32,000	36,000	9,500		10,000	139,000	95,000	40,000
3,100		6,000	74,000	32,000	36,000	10,000		10,000	139,000	95,000	40,000
3,200		6,000	74,000	32,000	36,000	10,200		12,000	163,000	114,000	45,000
3,300		6,000	74,000	32,000	36,000	10,500		12,000	163,000	114,000	45,000
3,400		6,000	74,000	34,000	36,000	11,000		12,000	163,000	114,000	45,000
3,500		6,000	74,000	34,000	36,000	11,500		12,000	163,000	114,000	45,000
3,600		6,000	74,000	34,000	36,000	12,000		12,000	163,000	114,000	45,000
3,700		6,000	74,000	34,000	36,000	12,300	31/64	14,000	182,000	133,000	45,000
3,800		6,000	97,000	45,000	36,000	12,500		14,000	182,000	133,000	45,000
3,900		6,000	97,000	45,000	36,000	12,700	1/2	14,000	182,000	133,000	45,000
4,000		6,000	97,000	45,000	36,000	13,000		14,000	182,000	133,000	45,000
4,100		6,000	97,000	45,000	36,000	13,500		14,000	182,000	133,000	45,000
4,200		6,000	97,000	45,000	36,000	14,000		14,000	182,000	133,000	45,000
4,300		6,000	97,000	45,000	36,000	14,500		16,000	204,000	152,000	48,000
4,400		6,000	97,000	45,000	36,000	15,000		16,000	204,000	152,000	48,000
4,500		6,000	97,000	45,000	36,000	15,500		16,000	204,000	152,000	48,000
4,700		6,000	97,000	45,000	36,000	16,000		16,000	204,000	152,000	48,000
4,800		6,000	97,000	57,000	36,000	16,500		18,000	223,000	171,000	48,000
4,900		6,000	97,000	57,000	36,000	17,000		18,000	223,000	171,000	48,000
5,000		6,000	97,000	57,000	36,000	17,500		18,000	223,000	171,000	48,000
5,500		6,000	97,000	57,000	36,000	18,000		18,000	223,000	171,000	48,000
6,000		6,000	97,000	57,000	36,000	18,500		20,000	244,000	190,000	50,000
6,500		8,000	116,000	76,000	36,000	19,000		20,000	244,000	190,000	50,000
6,800		8,000	116,000	76,000	36,000	19,500		20,000	244,000	190,000	50,000
7,000		8,000	116,000	76,000	36,000	20,000		20,000	244,000	190,000	50,000
7,500		8,000	116,000	76,000	36,000						
7,800		8,000	116,000	76,000	36,000						
8,000		8,000	116,000	76,000	36,000						
8,500		10,000	139,000	95,000	40,000						
9,000		10,000	139,000	95,000	40,000						

TS 100 R | TS 150 GG



TS-Drills mit Innenkühlung

Artikel-Nr. 89293



P	M	K	N	S	H
		•	○		

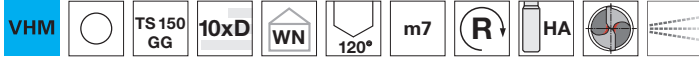

Ausspitzung $\geq \text{Ø } 3,000$ • Kegelmantelschliff • enge Durchmesser-toleranzen • sehr gute Bohrungsflächen • optimalen Kühlmitteldruck beachten

Grauguss, Temperguss, Sphäroguss

TS 100 R | TS 150 GG

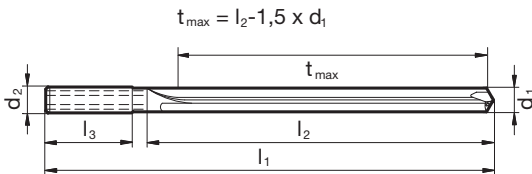

d1		d2 h6	l1	l2	l3	d1		d2 h6	l1	l2	l3
mm	inch	mm	mm	mm	mm	mm	inch	mm	mm	mm	mm
3,000		6,000	91,000	42,000	36,000	9,000		10,000	175,000	130,000	40,000
3,100		6,000	91,000	42,000	36,000	9,500		10,000	175,000	130,000	40,000
3,170	1/8	6,000	91,000	42,000	36,000	9,520	3/8	10,000	175,000	130,000	40,000
3,200		6,000	91,000	42,000	36,000	10,000		10,000	175,000	130,000	40,000
3,250		6,000	91,000	42,000	36,000	10,200		12,000	209,000	159,000	45,000
3,300		6,000	91,000	42,000	36,000	10,500		12,000	209,000	159,000	45,000
3,500		6,000	91,000	48,000	36,000	10,720	27/64	12,000	209,000	159,000	45,000
3,570	9/64	6,000	91,000	48,000	36,000	11,000		12,000	209,000	159,000	45,000
3,600		6,000	91,000	48,000	36,000	11,500		12,000	209,000	159,000	45,000
3,700		6,000	91,000	48,000	36,000	12,000		12,000	209,000	159,000	45,000
3,800		6,000	121,000	77,000	36,000	12,500		14,000	233,000	183,000	45,000
3,900		6,000	121,000	77,000	36,000	12,700	1/2	14,000	233,000	183,000	45,000
3,970	5/32	6,000	121,000	77,000	36,000	13,000		14,000	233,000	183,000	45,000
4,000		6,000	121,000	77,000	36,000	13,500		14,000	233,000	183,000	45,000
4,200		6,000	121,000	77,000	36,000	14,000		14,000	233,000	183,000	45,000
4,400		6,000	121,000	77,000	36,000	14,500		16,000	260,000	207,000	48,000
4,500		6,000	121,000	77,000	36,000	15,000		16,000	260,000	207,000	48,000
5,000		6,000	121,000	82,000	36,000	15,500		16,000	260,000	207,000	48,000
5,500		6,000	121,000	82,000	36,000	16,000		16,000	260,000	207,000	48,000
6,000		6,000	121,000	82,000	36,000	17,500		18,000	284,000	231,000	48,000
6,350	1/4	8,000	146,000	106,000	36,000	18,000		18,000	284,000	231,000	48,000
6,500		8,000	146,000	106,000	36,000	20,000		20,000	308,000	255,000	50,000
6,800		8,000	146,000	106,000	36,000						
7,000		8,000	146,000	106,000	36,000						
7,140	9/32	8,000	146,000	106,000	36,000						
7,500		8,000	146,000	106,000	36,000						
7,800		8,000	146,000	106,000	36,000						
8,000		8,000	146,000	106,000	36,000						
8,500		10,000	175,000	130,000	40,000						
8,730	11/32	10,000	175,000	130,000	40,000						



ANWENDUNGSBEISPIEL GEHÄUSE

Werkzeug-Typ	TS 100 R
Artikel-Nr.	89420
Durchmesser	17 mm
Bohrtiefe	50 mm
Material	EN-GJS-400-15
Kühlung	IK 20 bar
Schmierstoff	Emulsion
Maschine	BAZ
v_c	160 m/min
f	0,6 mm/U
Standweg	305 m



TS 100 ALU

▼ VORTEILE UND EIGENSCHAFTEN

- ▼ **verlässliche Spanabfuhr** und **perfektes Schnittverhalten** insbesondere in Aluminium-, Kupfer-, Messing- und Bronzelegierungen sowie Kunststoffen
- ▼ **optimale Spanbildung** in der gesamten Werkstoffbandbreite von weichen, zähen Nichteisenlegierungen bis hin zu spröden Aluguss- oder Messinglegierungen
- ▼ **geringe Prozesstemperaturen** verhindern Aufbauschneiden bei der Bearbeitung von Nichteisenmetallen

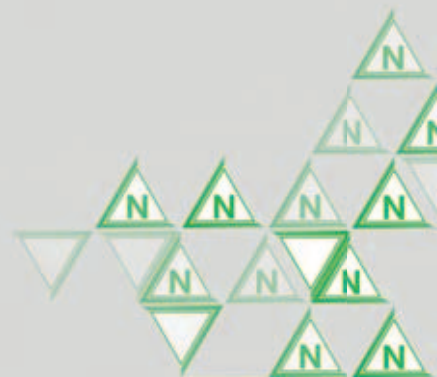

ALUMINIUM-, KUPFER-, MESSING- UND BRONZELEGIERUNGEN, KUNSTSTOFFE

scharfe, mikrobehandelte Schneidkanten
für perfektes Schneidverhalten auch
in wärmebehandelten AlSi-Legierungen

offene Ausspitzungsgeometrie
und **konkave Schneidkantenform**
für optimales Spanformungsverhalten

hohe Oberflächengüte
im Bereich **Ausspitzungs-,
Span- und Freiflächen**
reduziert die Prozess-
temperatur deutlich

blanke Ausführung
für beste Spanabfuhr

spezielle Hartmetallsorte
für die Bearbeitung von
Nichteisenmetallen



TS 150 GG

▼ VORTEILE UND EIGENSCHAFTEN

- ▼ **leistungsstarker VHM-Bohrer** mit Kühlkanälen für die Bearbeitung von **kurzspanenden Werkstoffen** wie Aluminium-Legierungen mit hohem Siliziumgehalt
- ▼ zur Herstellung von **Bohrungen** mit **extrem hoher Fluchtungsgenauigkeit**
- ▼ Bohren mit **hohem Zeitspanvolumen**
- ▼ auf Wunsch auch **mit Beschichtungen** lieferbar

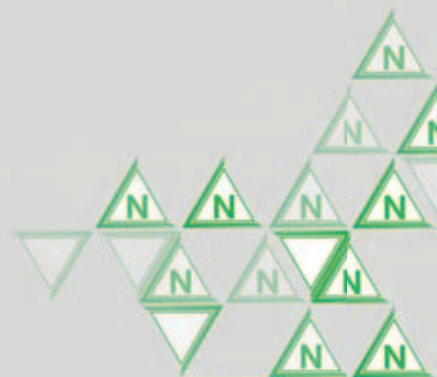

ALUMINIUM-, KUPFER-, MESSING- UND BRONZELEGIERUNGEN

speziell angepasste
Schneidengeometrie für die wirtschaftliche Bearbeitung von nahezu allen Aluminium- und Aluminiumguss-Legierungen

blanke Ausführung für optimale Spanabfuhr

Spezialausspitzung für exaktes Anbohren und geringen Mittenverlauf

vier Führungsfasen sichern die Geradheit und Rundheit der Bohrung



TS-Drills mit Innenkühlung

Artikel-Nr. 89560



P	M	K	N	S	H
			•		

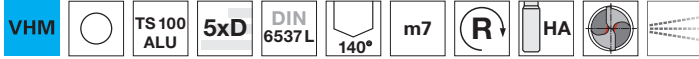

Ausspitzung $\geq \text{Ø } 3,000$ • Kegelmantelschliff • Hauptschneidenform konkav • optimierte Schneidengeometrie
 Aluminium und Al-Legierungen • Kupfer-, Messing-, und Bronze-Legierungen • Kunststoffe

TS 100 ALU | TS 150 GG

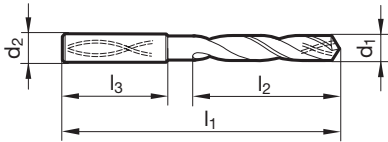

d1		d2 h6	l1	l2	l3	d1		d2 h6	l1	l2	l3
mm	inch	mm	mm	mm	mm	mm	inch	mm	mm	mm	mm
3,000		6,000	66,000	28,000	36,000	6,100		8,000	91,000	53,000	36,000
3,100		6,000	66,000	28,000	36,000	6,200		8,000	91,000	53,000	36,000
3,170	1/8	6,000	66,000	28,000	36,000	6,300		8,000	91,000	53,000	36,000
3,200		6,000	66,000	28,000	36,000	6,350	1/4	8,000	91,000	53,000	36,000
3,250		6,000	66,000	28,000	36,000	6,400		8,000	91,000	53,000	36,000
3,300		6,000	66,000	28,000	36,000	6,500		8,000	91,000	53,000	36,000
3,400		6,000	66,000	28,000	36,000	6,600		8,000	91,000	53,000	36,000
3,500		6,000	66,000	28,000	36,000	6,700		8,000	91,000	53,000	36,000
3,570	9/64	6,000	66,000	28,000	36,000	6,750	17/64	8,000	91,000	53,000	36,000
3,600		6,000	66,000	28,000	36,000	6,800		8,000	91,000	53,000	36,000
3,700		6,000	66,000	28,000	36,000	6,900		8,000	91,000	53,000	36,000
3,800		6,000	74,000	36,000	36,000	7,000		8,000	91,000	53,000	36,000
3,900		6,000	74,000	36,000	36,000	7,100		8,000	91,000	53,000	36,000
3,970	5/32	6,000	74,000	36,000	36,000	7,140	9/32	8,000	91,000	53,000	36,000
4,000		6,000	74,000	36,000	36,000	7,200		8,000	91,000	53,000	36,000
4,100		6,000	74,000	36,000	36,000	7,300		8,000	91,000	53,000	36,000
4,200		6,000	74,000	36,000	36,000	7,400		8,000	91,000	53,000	36,000
4,300		6,000	74,000	36,000	36,000	7,500		8,000	91,000	53,000	36,000
4,370	11/64	6,000	74,000	36,000	36,000	7,540	19/64	8,000	91,000	53,000	36,000
4,400		6,000	74,000	36,000	36,000	7,600		8,000	91,000	53,000	36,000
4,500		6,000	74,000	36,000	36,000	7,700		8,000	91,000	53,000	36,000
4,600		6,000	74,000	36,000	36,000	7,800		8,000	91,000	53,000	36,000
4,650		6,000	74,000	36,000	36,000	7,900		8,000	91,000	53,000	36,000
4,700		6,000	74,000	36,000	36,000	7,940	5/16	8,000	91,000	53,000	36,000
4,760	3/16	6,000	82,000	44,000	36,000	8,000		8,000	91,000	53,000	36,000
4,800		6,000	82,000	44,000	36,000	8,100		10,000	103,000	61,000	40,000
4,900		6,000	82,000	44,000	36,000	8,200		10,000	103,000	61,000	40,000
5,000		6,000	82,000	44,000	36,000	8,300		10,000	103,000	61,000	40,000
5,100		6,000	82,000	44,000	36,000	8,330	21/64	10,000	103,000	61,000	40,000
5,160	13/64	6,000	82,000	44,000	36,000	8,400		10,000	103,000	61,000	40,000
5,200		6,000	82,000	44,000	36,000	8,500		10,000	103,000	61,000	40,000
5,300		6,000	82,000	44,000	36,000	8,600		10,000	103,000	61,000	40,000
5,400		6,000	82,000	44,000	36,000	8,700		10,000	103,000	61,000	40,000
5,500		6,000	82,000	44,000	36,000	8,730	11/32	10,000	103,000	61,000	40,000
5,550		6,000	82,000	44,000	36,000	8,800		10,000	103,000	61,000	40,000
5,560	7/32	6,000	82,000	44,000	36,000	8,900		10,000	103,000	61,000	40,000
5,600		6,000	82,000	44,000	36,000	9,000		10,000	103,000	61,000	40,000
5,700		6,000	82,000	44,000	36,000	9,100		10,000	103,000	61,000	40,000
5,800		6,000	82,000	44,000	36,000	9,130	23/64	10,000	103,000	61,000	40,000
5,900		6,000	82,000	44,000	36,000	9,200		10,000	103,000	61,000	40,000
5,950	15/64	6,000	82,000	44,000	36,000	9,250		10,000	103,000	61,000	40,000
6,000		6,000	82,000	44,000	36,000	9,300		10,000	103,000	61,000	40,000



TS-Drills mit Innenkühlung

d1 mm	inch	d2 h6 mm	l1 mm	l2 mm	l3 mm	d1 mm	inch	d2 h6 mm	l1 mm	l2 mm	l3 mm
9,340		10,000	103,000	61,000	40,000	13,300		14,000	124,000	77,000	45,000
9,400		10,000	103,000	61,000	40,000	13,400		14,000	124,000	77,000	45,000
9,500		10,000	103,000	61,000	40,000	13,500		14,000	124,000	77,000	45,000
9,520	3/8	10,000	103,000	61,000	40,000	13,700		14,000	124,000	77,000	45,000
9,600		10,000	103,000	61,000	40,000	13,800		14,000	124,000	77,000	45,000
9,700		10,000	103,000	61,000	40,000	14,000		14,000	124,000	77,000	45,000
9,800		10,000	103,000	61,000	40,000	14,100		16,000	133,000	83,000	48,000
9,900		10,000	103,000	61,000	40,000	14,200		16,000	133,000	83,000	48,000
9,920	25/64	10,000	103,000	61,000	40,000	14,290	9/16	16,000	133,000	83,000	48,000
10,000		10,000	103,000	61,000	40,000	14,300		16,000	133,000	83,000	48,000
10,100		12,000	118,000	71,000	45,000	14,400		16,000	133,000	83,000	48,000
10,200		12,000	118,000	71,000	45,000	14,500		16,000	133,000	83,000	48,000
10,300		12,000	118,000	71,000	45,000	14,700		16,000	133,000	83,000	48,000
10,320	13/32	12,000	118,000	71,000	45,000	14,800		16,000	133,000	83,000	48,000
10,400		12,000	118,000	71,000	45,000	15,000		16,000	133,000	83,000	48,000
10,500		12,000	118,000	71,000	45,000	15,100		16,000	133,000	83,000	48,000
10,600		12,000	118,000	71,000	45,000	15,200		16,000	133,000	83,000	48,000
10,700		12,000	118,000	71,000	45,000	15,300		16,000	133,000	83,000	48,000
10,800		12,000	118,000	71,000	45,000	15,500		16,000	133,000	83,000	48,000
10,900		12,000	118,000	71,000	45,000	15,700		16,000	133,000	83,000	48,000
11,000		12,000	118,000	71,000	45,000	15,800		16,000	133,000	83,000	48,000
11,100		12,000	118,000	71,000	45,000	16,000		16,000	133,000	83,000	48,000
11,110	7/16	12,000	118,000	71,000	45,000	16,500		18,000	143,000	93,000	48,000
11,200		12,000	118,000	71,000	45,000	16,700		18,000	143,000	93,000	48,000
11,300		12,000	118,000	71,000	45,000	16,900		18,000	143,000	93,000	48,000
11,400		12,000	118,000	71,000	45,000	17,000		18,000	143,000	93,000	48,000
11,500		12,000	118,000	71,000	45,000	17,500		18,000	143,000	93,000	48,000
11,600		12,000	118,000	71,000	45,000	17,700		18,000	143,000	93,000	48,000
11,700		12,000	118,000	71,000	45,000	18,000		18,000	143,000	93,000	48,000
11,800		12,000	118,000	71,000	45,000	18,500		20,000	153,000	101,000	50,000
11,900		12,000	118,000	71,000	45,000	18,900		20,000	153,000	101,000	50,000
11,910	15/32	12,000	118,000	71,000	45,000	19,000		20,000	153,000	101,000	50,000
12,000		12,000	118,000	71,000	45,000	19,050	3/4	20,000	153,000	101,000	50,000
12,100		14,000	124,000	77,000	45,000	19,300		20,000	153,000	101,000	50,000
12,200		14,000	124,000	77,000	45,000	19,500		20,000	153,000	101,000	50,000
12,500		14,000	124,000	77,000	45,000	20,000		20,000	153,000	101,000	50,000
12,600		14,000	124,000	77,000	45,000						
12,700	1/2	14,000	124,000	77,000	45,000						
12,800		14,000	124,000	77,000	45,000						
12,900		14,000	124,000	77,000	45,000						
13,000		14,000	124,000	77,000	45,000						
13,100	33/64	14,000	124,000	77,000	45,000						

TS 100 ALU | TS 150 GG



TS-Drills mit Innenkühlung

Artikel-Nr. 89295



P	M	K	N	S	H
		○	●		

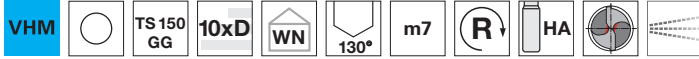

Ausspitzung $\geq \varnothing 3,000$ • Flächenanschliff • enge Durchmessertoleranzen • sehr gute Bohrungsoberflächen • optimalen Kühlmitteldruck beachten

Aluminium und Al-Legierungen • Kupfer-, Messing-, und Bronze-Legierungen • Kunststoffe

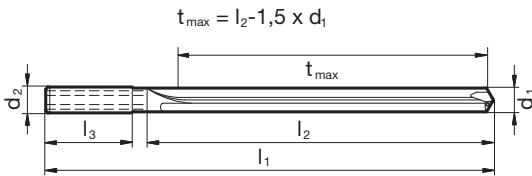

d1		d2 h6	l1	l2	l3	d1		d2 h6	l1	l2	l3
mm	inch	mm	mm	mm	mm	mm	inch	mm	mm	mm	mm
3,000		6,000	91,000	42,000	36,000	8,500		10,000	175,000	130,000	40,000
3,100		6,000	91,000	42,000	36,000	8,730	11/32	10,000	175,000	130,000	40,000
3,300		6,000	91,000	42,000	36,000	9,000		10,000	175,000	130,000	40,000
3,500		6,000	91,000	48,000	36,000	9,130	23/64	10,000	175,000	130,000	40,000
3,600		6,000	91,000	48,000	36,000	9,500		10,000	175,000	130,000	40,000
3,800		6,000	121,000	77,000	36,000	9,520	3/8	10,000	175,000	130,000	40,000
4,000		6,000	121,000	77,000	36,000	10,000		10,000	175,000	130,000	40,000
4,400		6,000	121,000	77,000	36,000	10,320	13/32	12,000	209,000	159,000	45,000
4,700		6,000	121,000	77,000	36,000	10,500		12,000	209,000	159,000	45,000
4,800		6,000	121,000	82,000	36,000	11,000		12,000	209,000	159,000	45,000
4,900		6,000	121,000	82,000	36,000	11,110	7/16	12,000	209,000	159,000	45,000
5,000		6,000	121,000	82,000	36,000	11,510	29/64	12,000	209,000	159,000	45,000
5,500		6,000	121,000	82,000	36,000	12,000		12,000	209,000	159,000	45,000
6,000		6,000	121,000	82,000	36,000	12,300	31/64	14,000	233,000	183,000	45,000
6,350	1/4	8,000	146,000	106,000	36,000	12,700	1/2	14,000	233,000	183,000	45,000
6,500		8,000	146,000	106,000	36,000	13,000		14,000	233,000	183,000	45,000
6,800		8,000	146,000	106,000	36,000	14,000		14,000	233,000	183,000	45,000
7,000		8,000	146,000	106,000	36,000	15,000		16,000	260,000	207,000	48,000
7,140	9/32	8,000	146,000	106,000	36,000	15,500		16,000	260,000	207,000	48,000
7,500		8,000	146,000	106,000	36,000	16,000		16,000	260,000	207,000	48,000
7,800		8,000	146,000	106,000	36,000	17,500		18,000	284,000	231,000	48,000
7,940	5/16	8,000	146,000	106,000	36,000	18,000		18,000	284,000	231,000	48,000
8,000		8,000	146,000	106,000	36,000	18,500		20,000	308,000	255,000	50,000
8,330	21/64	10,000	175,000	130,000	40,000	19,500		20,000	308,000	255,000	50,000

TS 100 ALU | TS 150 GG



ANWENDUNGSBEISPIEL GEHÄUSE

Werkzeug-Typ	TS 100 ALU
Artikel-Nr.	89560
Durchmesser	10 mm
Bohrtiefe	50 mm
Material	G-AlSi9Mg
Kühlung	IK 60 bar
Schmierstoff	Emulsion
Maschine	BAZ
v_c	310 m/min
f	0,5 mm/U
Standweg	80 m



TS 100 H

▼ VORTEILE UND EIGENSCHAFTEN

- ▼ hochfeste Werkstoffe und Sonderlegierungen können dank neu entwickelter Schneidengeometrie und extrem harter **TiAlSiN-Beschichtung präzise und effizient** bearbeitet werden
- ▼ **ideale Lösung** für die Anwendung in der **Automobilindustrie, der Luft- und Raumfahrttechnik, dem Energieanlagenbau** sowie der **chemischen Industrie**



LEGIERTE UND UNLEGIERTE HOCHFESTE STÄHLE, GEHÄRTETE STÄHLE, SONDER- UND TITANLEGIERUNGEN

Negativfase schützt die Schneidecken und sichert die hervorragende Oberflächenqualität am Bauteil

robuste Schneiden und optimale Spanbildung durch **Kegelmantelanschliff** mit **konkaven Schneiden** und spezieller **Ausspitzungsgeometrie**

vier Führungsfasen für höchste Bohrungsqualität und minimierten Schneideckenverschleiß

spezielles Nutprofil für perfekte Spanabfuhr, auch bei langspanenden Werkstoffen

Die neue, eigenentwickelte **TiAlSiN-Schicht** ist eine der härtesten nitridischen Schichten am Markt. Dank ihrer Nanocomposite-Struktur mit einem Schichtaufbau aus TiAlN und SiN erreicht sie die **extreme Härte von 5500 HV**.



TS-Drills ohne Innenkühlung

Artikel-Nr. 89422



P	M	K	N	S	H
•				•	○

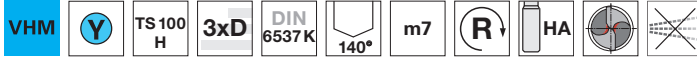

Ausspitzung $\geq \text{Ø } 3,000$ • Kegelmantelschliff • Hauptschneidenform leicht konkav • optimierte Schneidengeometrie
 legierte und hochfeste Stähle bis 1400 N/mm^2 • Inconel, Hastelloy, Monel • Titan und Titanlegierungen

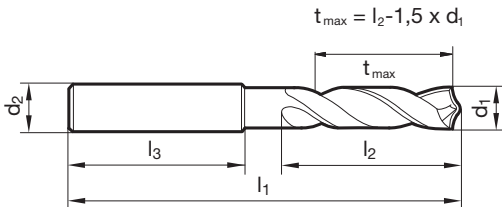

d1		d2 h6	l1	l2	l3	d1		d2 h6	l1	l2	l3
mm	inch	mm	mm	mm	mm	mm	inch	mm	mm	mm	mm
3,000		6,000	62,000	20,000	36,000	6,100		8,000	79,000	34,000	36,000
3,100		6,000	62,000	20,000	36,000	6,200		8,000	79,000	34,000	36,000
3,170	1/8	6,000	62,000	20,000	36,000	6,300		8,000	79,000	34,000	36,000
3,200		6,000	62,000	20,000	36,000	6,350	1/4	8,000	79,000	34,000	36,000
3,250		6,000	62,000	20,000	36,000	6,400		8,000	79,000	34,000	36,000
3,300		6,000	62,000	20,000	36,000	6,500		8,000	79,000	34,000	36,000
3,400		6,000	62,000	20,000	36,000	6,600		8,000	79,000	34,000	36,000
3,500		6,000	62,000	20,000	36,000	6,700		8,000	79,000	34,000	36,000
3,570	9/64	6,000	62,000	20,000	36,000	6,750	17/64	8,000	79,000	34,000	36,000
3,600		6,000	62,000	20,000	36,000	6,800		8,000	79,000	34,000	36,000
3,700		6,000	62,000	20,000	36,000	6,900		8,000	79,000	34,000	36,000
3,800		6,000	66,000	24,000	36,000	7,000		8,000	79,000	34,000	36,000
3,900		6,000	66,000	24,000	36,000	7,100		8,000	79,000	41,000	36,000
3,970	5/32	6,000	66,000	24,000	36,000	7,140	9/32	8,000	79,000	41,000	36,000
4,000		6,000	66,000	24,000	36,000	7,200		8,000	79,000	41,000	36,000
4,100		6,000	66,000	24,000	36,000	7,300		8,000	79,000	41,000	36,000
4,200		6,000	66,000	24,000	36,000	7,400		8,000	79,000	41,000	36,000
4,300		6,000	66,000	24,000	36,000	7,500		8,000	79,000	41,000	36,000
4,370	11/64	6,000	66,000	24,000	36,000	7,540	19/64	8,000	79,000	41,000	36,000
4,400		6,000	66,000	24,000	36,000	7,600		8,000	79,000	41,000	36,000
4,500		6,000	66,000	24,000	36,000	7,700		8,000	79,000	41,000	36,000
4,600		6,000	66,000	24,000	36,000	7,800		8,000	79,000	41,000	36,000
4,650		6,000	66,000	24,000	36,000	7,900		8,000	79,000	41,000	36,000
4,700		6,000	66,000	24,000	36,000	7,940	5/16	8,000	79,000	41,000	36,000
4,760	3/16	6,000	66,000	28,000	36,000	8,000		8,000	79,000	41,000	36,000
4,800		6,000	66,000	28,000	36,000	8,100		10,000	89,000	47,000	40,000
4,900		6,000	66,000	28,000	36,000	8,200		10,000	89,000	47,000	40,000
5,000		6,000	66,000	28,000	36,000	8,300		10,000	89,000	47,000	40,000
5,100		6,000	66,000	28,000	36,000	8,330	21/64	10,000	89,000	47,000	40,000
5,160	13/64	6,000	66,000	28,000	36,000	8,400		10,000	89,000	47,000	40,000
5,200		6,000	66,000	28,000	36,000	8,500		10,000	89,000	47,000	40,000
5,300		6,000	66,000	28,000	36,000	8,600		10,000	89,000	47,000	40,000
5,400		6,000	66,000	28,000	36,000	8,700		10,000	89,000	47,000	40,000
5,500		6,000	66,000	28,000	36,000	8,730	11/32	10,000	89,000	47,000	40,000
5,550		6,000	66,000	28,000	36,000	8,800		10,000	89,000	47,000	40,000
5,560	7/32	6,000	66,000	28,000	36,000	8,900		10,000	89,000	47,000	40,000
5,600		6,000	66,000	28,000	36,000	9,000		10,000	89,000	47,000	40,000
5,700		6,000	66,000	28,000	36,000	9,100		10,000	89,000	47,000	40,000
5,800		6,000	66,000	28,000	36,000	9,130	23/64	10,000	89,000	47,000	40,000
5,900		6,000	66,000	28,000	36,000	9,200		10,000	89,000	47,000	40,000
5,950	15/64	6,000	66,000	28,000	36,000	9,250		10,000	89,000	47,000	40,000
6,000		6,000	66,000	28,000	36,000	9,300		10,000	89,000	47,000	40,000

TS 100 H



TS-Drills ohne Innenkühlung

d1 mm	inch	d2 h6 mm	l1 mm	l2 mm	l3 mm	d1 mm	inch	d2 h6 mm	l1 mm	l2 mm	l3 mm
9,400		10,000	89,000	47,000	40,000	13,000		14,000	107,000	60,000	45,000
9,500		10,000	89,000	47,000	40,000	13,300		14,000	107,000	60,000	45,000
9,520	3/8	10,000	89,000	47,000	40,000	13,500		14,000	107,000	60,000	45,000
9,600		10,000	89,000	47,000	40,000	13,700		14,000	107,000	60,000	45,000
9,700		10,000	89,000	47,000	40,000	14,000		14,000	107,000	60,000	45,000
9,800		10,000	89,000	47,000	40,000	14,200		16,000	115,000	65,000	48,000
9,900		10,000	89,000	47,000	40,000	14,290	9/16	16,000	115,000	65,000	48,000
9,920	25/64	10,000	89,000	47,000	40,000	14,300		16,000	115,000	65,000	48,000
10,000		10,000	89,000	47,000	40,000	14,500		16,000	115,000	65,000	48,000
10,100		12,000	102,000	55,000	45,000	14,700		16,000	115,000	65,000	48,000
10,200		12,000	102,000	55,000	45,000	15,000		16,000	115,000	65,000	48,000
10,300		12,000	102,000	55,000	45,000	15,200		16,000	115,000	65,000	48,000
10,320	13/32	12,000	102,000	55,000	45,000	15,300		16,000	115,000	65,000	48,000
10,400		12,000	102,000	55,000	45,000	15,500		16,000	115,000	65,000	48,000
10,500		12,000	102,000	55,000	45,000	15,700		16,000	115,000	65,000	48,000
10,600		12,000	102,000	55,000	45,000	16,000		16,000	115,000	65,000	48,000
10,700		12,000	102,000	55,000	45,000	16,300		18,000	123,000	73,000	48,000
10,800		12,000	102,000	55,000	45,000	16,500		18,000	123,000	73,000	48,000
10,900		12,000	102,000	55,000	45,000	16,900		18,000	123,000	73,000	48,000
11,000		12,000	102,000	55,000	45,000	17,000		18,000	123,000	73,000	48,000
11,100		12,000	102,000	55,000	45,000	17,300		18,000	123,000	73,000	48,000
11,110	7/16	12,000	102,000	55,000	45,000	17,500		18,000	123,000	73,000	48,000
11,200		12,000	102,000	55,000	45,000	18,000		18,000	123,000	73,000	48,000
11,300		12,000	102,000	55,000	45,000	18,500		20,000	131,000	79,000	50,000
11,400		12,000	102,000	55,000	45,000	18,900		20,000	131,000	79,000	50,000
11,500		12,000	102,000	55,000	45,000	19,000		20,000	131,000	79,000	50,000
11,600		12,000	102,000	55,000	45,000	19,050	3/4	20,000	131,000	79,000	50,000
11,700		12,000	102,000	55,000	45,000	19,300		20,000	131,000	79,000	50,000
11,800		12,000	102,000	55,000	45,000	19,500		20,000	131,000	79,000	50,000
11,900		12,000	102,000	55,000	45,000	20,000		20,000	131,000	79,000	50,000
11,910	15/32	12,000	102,000	55,000	45,000						
12,000		12,000	102,000	55,000	45,000						
12,200		14,000	107,000	60,000	45,000						
12,500		14,000	107,000	60,000	45,000						
12,700	1/2	14,000	107,000	60,000	45,000						
12,800		14,000	107,000	60,000	45,000						



TS-Drills mit Innenkühlung

Artikel-Nr. 89423



P	M	K	N	S	H
•				•	○

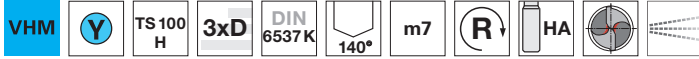

Ausspitzung $\geq \varnothing 3,000$ • Kegelmantelschliff • Hauptschneidenform leicht konkav • optimierte Schneidengeometrie
 legierte und hochfeste Stähle bis 1400 N/mm² • Inconel, Hastelloy, Monel • Titan und Titanlegierungen

Artikel-Nr. 89424



P	M	K	N	S	H
•				•	○

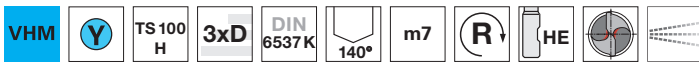

Ausspitzung $\geq \varnothing 3,000$ • Kegelmantelschliff • Hauptschneidenform leicht konkav • optimierte Schneidengeometrie
 legierte und hochfeste Stähle bis 1400 N/mm² • Inconel, Hastelloy, Monel • Titan und Titanlegierungen

TS 100 H

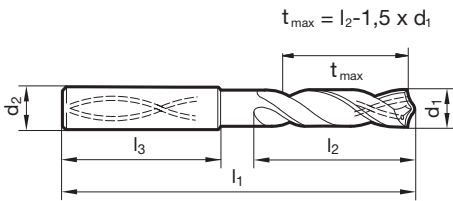

d1	inch	d2 h6	l1	l2	l3	d1	inch	d2 h6	l1	l2	l3
mm		mm	mm	mm	mm	mm		mm	mm	mm	mm
3,000		6,000	62,000	20,000	36,000	5,200		6,000	66,000	28,000	36,000
3,100		6,000	62,000	20,000	36,000	5,300		6,000	66,000	28,000	36,000
3,170	1/8	6,000	62,000	20,000	36,000	5,400		6,000	66,000	28,000	36,000
3,200		6,000	62,000	20,000	36,000	5,500		6,000	66,000	28,000	36,000
3,250		6,000	62,000	20,000	36,000	5,550		6,000	66,000	28,000	36,000
3,300		6,000	62,000	20,000	36,000	5,560	7/32	6,000	66,000	28,000	36,000
3,400		6,000	62,000	20,000	36,000	5,600		6,000	66,000	28,000	36,000
3,500		6,000	62,000	20,000	36,000	5,700		6,000	66,000	28,000	36,000
3,570	9/64	6,000	62,000	20,000	36,000	5,800		6,000	66,000	28,000	36,000
3,600		6,000	62,000	20,000	36,000	5,900		6,000	66,000	28,000	36,000
3,700		6,000	62,000	20,000	36,000	5,950	15/64	6,000	66,000	28,000	36,000
3,800		6,000	66,000	24,000	36,000	6,000		6,000	66,000	28,000	36,000
3,900		6,000	66,000	24,000	36,000	6,100		8,000	79,000	34,000	36,000
3,970	5/32	6,000	66,000	24,000	36,000	6,200		8,000	79,000	34,000	36,000
4,000		6,000	66,000	24,000	36,000	6,300		8,000	79,000	34,000	36,000
4,100		6,000	66,000	24,000	36,000	6,350	1/4	8,000	79,000	34,000	36,000
4,200		6,000	66,000	24,000	36,000	6,400		8,000	79,000	34,000	36,000
4,300		6,000	66,000	24,000	36,000	6,500		8,000	79,000	34,000	36,000
4,370	11/64	6,000	66,000	24,000	36,000	6,600		8,000	79,000	34,000	36,000
4,400		6,000	66,000	24,000	36,000	6,700		8,000	79,000	34,000	36,000
4,500		6,000	66,000	24,000	36,000	6,750	17/64	8,000	79,000	34,000	36,000
4,600		6,000	66,000	24,000	36,000	6,800		8,000	79,000	34,000	36,000
4,650		6,000	66,000	24,000	36,000	6,900		8,000	79,000	34,000	36,000
4,700		6,000	66,000	24,000	36,000	7,000		8,000	79,000	34,000	36,000
4,760	3/16	6,000	66,000	28,000	36,000	7,100		8,000	79,000	41,000	36,000
4,800		6,000	66,000	28,000	36,000	7,140	9/32	8,000	79,000	41,000	36,000
4,900		6,000	66,000	28,000	36,000	7,200		8,000	79,000	41,000	36,000
5,000		6,000	66,000	28,000	36,000	7,300		8,000	79,000	41,000	36,000
5,100		6,000	66,000	28,000	36,000	7,400		8,000	79,000	41,000	36,000
5,160	13/64	6,000	66,000	28,000	36,000	7,500		8,000	79,000	41,000	36,000



TS-Drills mit Innenkühlung

d1 mm	inch	d2 h6 mm	l1 mm	l2 mm	l3 mm	d1 mm	inch	d2 h6 mm	l1 mm	l2 mm	l3 mm
7,540	19/64	8,000	79,000	41,000	36,000	11,400		12,000	102,000	55,000	45,000
7,600		8,000	79,000	41,000	36,000	11,500		12,000	102,000	55,000	45,000
7,700		8,000	79,000	41,000	36,000	11,600		12,000	102,000	55,000	45,000
7,800		8,000	79,000	41,000	36,000	11,700		12,000	102,000	55,000	45,000
7,900		8,000	79,000	41,000	36,000	11,800		12,000	102,000	55,000	45,000
7,940	5/16	8,000	79,000	41,000	36,000	11,900		12,000	102,000	55,000	45,000
8,000		8,000	79,000	41,000	36,000	11,910	15/32	12,000	102,000	55,000	45,000
8,100		10,000	89,000	47,000	40,000	12,000		12,000	102,000	55,000	45,000
8,200		10,000	89,000	47,000	40,000	12,200		14,000	107,000	60,000	45,000
8,300		10,000	89,000	47,000	40,000	12,500		14,000	107,000	60,000	45,000
8,330	21/64	10,000	89,000	47,000	40,000	12,700	1/2	14,000	107,000	60,000	45,000
8,400		10,000	89,000	47,000	40,000	12,800		14,000	107,000	60,000	45,000
8,500		10,000	89,000	47,000	40,000	13,000		14,000	107,000	60,000	45,000
8,600		10,000	89,000	47,000	40,000	13,300		14,000	107,000	60,000	45,000
8,700		10,000	89,000	47,000	40,000	13,500		14,000	107,000	60,000	45,000
8,730	11/32	10,000	89,000	47,000	40,000	13,700		14,000	107,000	60,000	45,000
8,800		10,000	89,000	47,000	40,000	14,000		14,000	107,000	60,000	45,000
8,900		10,000	89,000	47,000	40,000	14,200		16,000	115,000	65,000	48,000
9,000		10,000	89,000	47,000	40,000	14,290	9/16	16,000	115,000	65,000	48,000
9,100		10,000	89,000	47,000	40,000	14,300		16,000	115,000	65,000	48,000
9,130	23/64	10,000	89,000	47,000	40,000	14,500		16,000	115,000	65,000	48,000
9,200		10,000	89,000	47,000	40,000	14,700		16,000	115,000	65,000	48,000
9,250		10,000	89,000	47,000	40,000	15,000		16,000	115,000	65,000	48,000
9,300		10,000	89,000	47,000	40,000	15,200		16,000	115,000	65,000	48,000
9,400		10,000	89,000	47,000	40,000	15,300		16,000	115,000	65,000	48,000
9,500		10,000	89,000	47,000	40,000	15,500		16,000	115,000	65,000	48,000
9,520	3/8	10,000	89,000	47,000	40,000	15,700		16,000	115,000	65,000	48,000
9,600		10,000	89,000	47,000	40,000	16,000		16,000	115,000	65,000	48,000
9,700		10,000	89,000	47,000	40,000	16,300		18,000	123,000	73,000	48,000
9,800		10,000	89,000	47,000	40,000	16,500		18,000	123,000	73,000	48,000
9,900		10,000	89,000	47,000	40,000	16,900		18,000	123,000	73,000	48,000
9,920	25/64	10,000	89,000	47,000	40,000	17,000		18,000	123,000	73,000	48,000
10,000		10,000	89,000	47,000	40,000	17,300		18,000	123,000	73,000	48,000
10,100		12,000	102,000	55,000	45,000	17,500		18,000	123,000	73,000	48,000
10,200		12,000	102,000	55,000	45,000	18,000		18,000	123,000	73,000	48,000
10,300		12,000	102,000	55,000	45,000	18,500		20,000	131,000	79,000	50,000
10,320	13/32	12,000	102,000	55,000	45,000	18,900		20,000	131,000	79,000	50,000
10,400		12,000	102,000	55,000	45,000	19,000		20,000	131,000	79,000	50,000
10,500		12,000	102,000	55,000	45,000	19,050	3/4	20,000	131,000	79,000	50,000
10,600		12,000	102,000	55,000	45,000	19,300		20,000	131,000	79,000	50,000
10,700		12,000	102,000	55,000	45,000	19,500		20,000	131,000	79,000	50,000
10,800		12,000	102,000	55,000	45,000	20,000		20,000	131,000	79,000	50,000
10,900		12,000	102,000	55,000	45,000						
11,000		12,000	102,000	55,000	45,000						
11,100		12,000	102,000	55,000	45,000						
11,110	7/16	12,000	102,000	55,000	45,000						
11,200		12,000	102,000	55,000	45,000						
11,300		12,000	102,000	55,000	45,000						

TS 100 H



TS-Drills mit Innenkühlung

Artikel-Nr. 89425



P	M	K	N	S	H
•				•	○

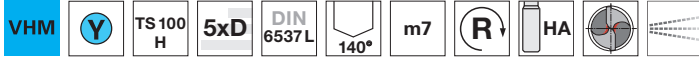

Ausspitzung $\geq \varnothing 3,000$ • Kegelmantelschliff • Hauptschneidenform leicht konkav • optimierte Schneidengeometrie
 legierte und hochfeste Stähle bis 1400 N/mm² • Inconel, Hastelloy, Monel • Titan und Titanlegierungen

Artikel-Nr. 89426



P	M	K	N	S	H
•				•	○

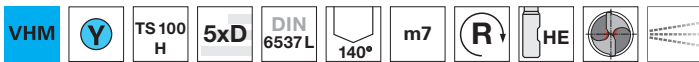

Ausspitzung $\geq \varnothing 3,000$ • Kegelmantelschliff • Hauptschneidenform leicht konkav • optimierte Schneidengeometrie
 legierte und hochfeste Stähle bis 1400 N/mm² • Inconel, Hastelloy, Monel • Titan und Titanlegierungen

$$t_{\max} = l_2 - 1,5 \times d_1$$

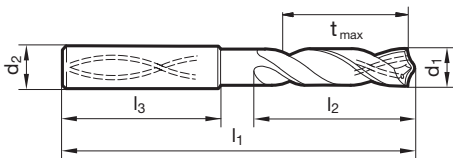

d1	inch	d2 h6	l1	l2	l3	d1	inch	d2 h6	l1	l2	l3
mm		mm	mm	mm	mm	mm		mm	mm	mm	mm
3,000		6,000	66,000	28,000	36,000	5,200		6,000	82,000	44,000	36,000
3,100		6,000	66,000	28,000	36,000	5,300		6,000	82,000	44,000	36,000
3,170	1/8	6,000	66,000	28,000	36,000	5,400		6,000	82,000	44,000	36,000
3,200		6,000	66,000	28,000	36,000	5,500		6,000	82,000	44,000	36,000
3,250		6,000	66,000	28,000	36,000	5,550		6,000	82,000	44,000	36,000
3,300		6,000	66,000	28,000	36,000	5,560	7/32	6,000	82,000	44,000	36,000
3,400		6,000	66,000	28,000	36,000	5,600		6,000	82,000	44,000	36,000
3,500		6,000	66,000	28,000	36,000	5,700		6,000	82,000	44,000	36,000
3,570	9/64	6,000	66,000	28,000	36,000	5,800		6,000	82,000	44,000	36,000
3,600		6,000	66,000	28,000	36,000	5,900		6,000	82,000	44,000	36,000
3,700		6,000	66,000	28,000	36,000	5,950	15/64	6,000	82,000	44,000	36,000
3,800		6,000	74,000	36,000	36,000	6,000		6,000	82,000	44,000	36,000
3,900		6,000	74,000	36,000	36,000	6,100		8,000	91,000	53,000	36,000
3,970	5/32	6,000	74,000	36,000	36,000	6,200		8,000	91,000	53,000	36,000
4,000		6,000	74,000	36,000	36,000	6,300		8,000	91,000	53,000	36,000
4,100		6,000	74,000	36,000	36,000	6,350	1/4	8,000	91,000	53,000	36,000
4,200		6,000	74,000	36,000	36,000	6,400		8,000	91,000	53,000	36,000
4,300		6,000	74,000	36,000	36,000	6,500		8,000	91,000	53,000	36,000
4,370	11/64	6,000	74,000	36,000	36,000	6,600		8,000	91,000	53,000	36,000
4,400		6,000	74,000	36,000	36,000	6,700		8,000	91,000	53,000	36,000
4,500		6,000	74,000	36,000	36,000	6,750	17/64	8,000	91,000	53,000	36,000
4,600		6,000	74,000	36,000	36,000	6,800		8,000	91,000	53,000	36,000
4,650		6,000	74,000	36,000	36,000	6,900		8,000	91,000	53,000	36,000
4,700		6,000	74,000	36,000	36,000	7,000		8,000	91,000	53,000	36,000
4,760	3/16	6,000	82,000	44,000	36,000	7,100		8,000	91,000	53,000	36,000
4,800		6,000	82,000	44,000	36,000	7,140	9/32	8,000	91,000	53,000	36,000
4,900		6,000	82,000	44,000	36,000	7,200		8,000	91,000	53,000	36,000
5,000		6,000	82,000	44,000	36,000	7,300		8,000	91,000	53,000	36,000
5,100		6,000	82,000	44,000	36,000	7,400		8,000	91,000	53,000	36,000
5,160	13/64	6,000	82,000	44,000	36,000	7,500		8,000	91,000	53,000	36,000

TS 100 H



TS-Drills mit Innenkühlung

d1 mm	inch	d2 h6 mm	l1 mm	l2 mm	l3 mm	d1 mm	inch	d2 h6 mm	l1 mm	l2 mm	l3 mm
7,540	19/64	8,000	91,000	53,000	36,000	11,400		12,000	118,000	71,000	45,000
7,600		8,000	91,000	53,000	36,000	11,500		12,000	118,000	71,000	45,000
7,700		8,000	91,000	53,000	36,000	11,600		12,000	118,000	71,000	45,000
7,800		8,000	91,000	53,000	36,000	11,700		12,000	118,000	71,000	45,000
7,900		8,000	91,000	53,000	36,000	11,800		12,000	118,000	71,000	45,000
7,940	5/16	8,000	91,000	53,000	36,000	11,900		12,000	118,000	71,000	45,000
8,000		8,000	91,000	53,000	36,000	11,910	15/32	12,000	118,000	71,000	45,000
8,100		10,000	103,000	61,000	40,000	12,000		12,000	118,000	71,000	45,000
8,200		10,000	103,000	61,000	40,000	12,200		14,000	124,000	77,000	45,000
8,300		10,000	103,000	61,000	40,000	12,500		14,000	124,000	77,000	45,000
8,330	21/64	10,000	103,000	61,000	40,000	12,700	1/2	14,000	124,000	77,000	45,000
8,400		10,000	103,000	61,000	40,000	12,800		14,000	124,000	77,000	45,000
8,500		10,000	103,000	61,000	40,000	13,000		14,000	124,000	77,000	45,000
8,600		10,000	103,000	61,000	40,000	13,300		14,000	124,000	77,000	45,000
8,700		10,000	103,000	61,000	40,000	13,500		14,000	124,000	77,000	45,000
8,730	11/32	10,000	103,000	61,000	40,000	13,700		14,000	124,000	77,000	45,000
8,800		10,000	103,000	61,000	40,000	14,000		14,000	124,000	77,000	45,000
8,900		10,000	103,000	61,000	40,000	14,200		16,000	133,000	83,000	48,000
9,000		10,000	103,000	61,000	40,000	14,290	9/16	16,000	133,000	83,000	48,000
9,100		10,000	103,000	61,000	40,000	14,300		16,000	133,000	83,000	48,000
9,130	23/64	10,000	103,000	61,000	40,000	14,500		16,000	133,000	83,000	48,000
9,200		10,000	103,000	61,000	40,000	14,700		16,000	133,000	83,000	48,000
9,250		10,000	103,000	61,000	40,000	15,000		16,000	133,000	83,000	48,000
9,300		10,000	103,000	61,000	40,000	15,200		16,000	133,000	83,000	48,000
9,400		10,000	103,000	61,000	40,000	15,300		16,000	133,000	83,000	48,000
9,500		10,000	103,000	61,000	40,000	15,500		16,000	133,000	83,000	48,000
9,520	3/8	10,000	103,000	61,000	40,000	15,700		16,000	133,000	83,000	48,000
9,600		10,000	103,000	61,000	40,000	16,000		16,000	133,000	83,000	48,000
9,700		10,000	103,000	61,000	40,000	16,300		18,000	143,000	93,000	48,000
9,800		10,000	103,000	61,000	40,000	16,500		18,000	143,000	93,000	48,000
9,900		10,000	103,000	61,000	40,000	16,900		18,000	143,000	93,000	48,000
9,920	25/64	10,000	103,000	61,000	40,000	17,000		18,000	143,000	93,000	48,000
10,000		10,000	103,000	61,000	40,000	17,300		18,000	143,000	93,000	48,000
10,100		12,000	118,000	71,000	45,000	17,500		18,000	143,000	93,000	48,000
10,200		12,000	118,000	71,000	45,000	18,000		18,000	143,000	93,000	48,000
10,300		12,000	118,000	71,000	45,000	18,500		20,000	153,000	101,000	50,000
10,320	13/32	12,000	118,000	71,000	45,000	18,900		20,000	153,000	101,000	50,000
10,400		12,000	118,000	71,000	45,000	19,000		20,000	153,000	101,000	50,000
10,500		12,000	118,000	71,000	45,000	19,050	3/4	20,000	153,000	101,000	50,000
10,600		12,000	118,000	71,000	45,000	19,300		20,000	153,000	101,000	50,000
10,700		12,000	118,000	71,000	45,000	19,500		20,000	153,000	101,000	50,000
10,800		12,000	118,000	71,000	45,000	20,000		20,000	153,000	101,000	50,000
10,900		12,000	118,000	71,000	45,000						
11,000		12,000	118,000	71,000	45,000						
11,100		12,000	118,000	71,000	45,000						
11,110	7/16	12,000	118,000	71,000	45,000						
11,200		12,000	118,000	71,000	45,000						
11,300		12,000	118,000	71,000	45,000						

TS 100 H



TS-Drills mit Innenkühlung

Artikel-Nr. 89427



P	M	K	N	S	H
•				•	○

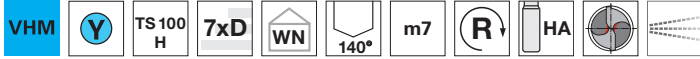

Ausspitzung $\geq \text{Ø } 3,000$ • Kegelmantelschliff • Hauptschneidenform leicht konkav • optimierte Schneidengeometrie
 legierte und hochfeste Stähle bis 1400 N/mm² • Inconel, Hastelloy, Monel • Titan und Titanlegierungen

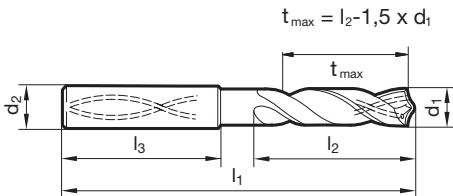

d1	inch	d2 h6	l1	l2	l3	d1	inch	d2 h6	l1	l2	l3
mm		mm	mm	mm	mm	mm		mm	mm	mm	mm
3,000		6,000	70,000	30,000	36,000	9,250		10,000	139,000	95,000	40,000
3,250		6,000	70,000	30,000	36,000	9,400		10,000	139,000	95,000	40,000
3,300		6,000	70,000	30,000	36,000	9,500		10,000	139,000	95,000	40,000
3,400		6,000	75,000	35,500	36,000	10,000		10,000	139,000	95,000	40,000
3,500		6,000	75,000	35,500	36,000	10,200		12,000	155,000	106,000	45,000
3,700		6,000	75,000	35,500	36,000	10,400		12,000	155,000	106,000	45,000
4,000		6,000	75,000	37,500	36,000	10,500		12,000	155,000	106,000	45,000
4,200		6,000	75,000	37,500	36,000	10,800		12,000	155,000	106,000	45,000
4,300		6,000	85,000	45,000	36,000	11,000		12,000	155,000	106,000	45,000
4,500		6,000	85,000	45,000	36,000	11,300		12,000	163,000	114,000	45,000
4,650		6,000	85,000	45,000	36,000	11,400		12,000	163,000	114,000	45,000
5,000		6,000	90,000	50,000	36,000	11,500		12,000	163,000	114,000	45,000
5,100		6,000	90,000	50,000	36,000	12,000		12,000	163,000	114,000	45,000
5,200		6,000	90,000	50,000	36,000	12,500		14,000	182,000	133,000	45,000
5,500		6,000	97,000	57,000	36,000	13,000		14,000	182,000	133,000	45,000
5,550		6,000	97,000	57,000	36,000	13,100	33/64	14,000	182,000	133,000	45,000
6,000		6,000	97,000	57,000	36,000	13,500		14,000	182,000	133,000	45,000
6,500		8,000	106,000	66,000	36,000	14,000		14,000	182,000	133,000	45,000
6,750	17/64	8,000	106,000	66,000	36,000	14,500		16,000	204,000	152,000	48,000
6,800		8,000	106,000	66,000	36,000	15,000		16,000	204,000	152,000	48,000
6,900		8,000	116,000	76,000	36,000	15,100		16,000	204,000	152,000	48,000
7,000		8,000	116,000	76,000	36,000	15,500		16,000	204,000	152,000	48,000
7,400		8,000	116,000	76,000	36,000	16,000		16,000	204,000	152,000	48,000
7,500		8,000	116,000	76,000	36,000						
7,800		8,000	116,000	76,000	36,000						
8,000		8,000	116,000	76,000	36,000						
8,500		10,000	131,000	87,000	40,000						
8,600		10,000	131,000	87,000	40,000						
8,800		10,000	131,000	87,000	40,000						
9,000		10,000	131,000	87,000	40,000						

TS 100 H



ANWENDUNGSBEISPIEL KURBELWELLE

Werkzeug-Typ	TS 100 H
Artikel-Nr.	89425
Durchmesser	14 mm
Bohrtiefe	65 mm
Material	42CrMoS4
Kühlung	IK 40 bar
Schmierstoff	Emulsion
Maschine	BAZ
v_c	105 m/min
f	0,35 mm/U
Standweg	55 m

VHM-KLEINSTBOHRER

▼ VORTEILE UND EIGENSCHAFTEN

- ▼ für **Bohrtiefen bis 4xD und 7xD** stehen VHM-Kleinstbohrer ohne Innenkühlung im **Durchmesserbereich von 0,5 bis 3,0 mm** zur Wahl
- ▼ für Bohrungen **bis 8xD und 15xD** werden VHM-Kleinstbohrer **mit Innenkühlung** im **Durchmesserbereich von 1,4 bis 3,0 mm** eingesetzt
- ▼ dank der **optimierten Werkzeuggeometrie** ist bei den VHM-Kleinstbohrern von Hartner bei Bohrtiefen bis 15xD **kein Entspannen notwendig**



ALLGEMEINE STAHLBEABREITUNG BIS $\sim 1200 \text{ N/mm}^2$

▼ UNIVERSELLE ANWENDUNG

geschliffener Schneidkantenabzug
für hohe Prozesssicherheit, auch in
kritischen Anwendungen

Spezialausspitzung für exaktes
Anbohren und maßhaltige Bohrungen

optimiertes Nutprofil für hohe
Stabilität und gute Spanabfuhr

der einlagige Aufbau der **TiAlN-Schicht**
eignet sich besonders für die Beschichtung
von Kleinwerkzeugen und sorgt für hohe
Verschleißfestigkeit und gute Spanabfuhr

die **Werkzeuggeometrie**
ist für den universellen
Einsatz in nahezu allen
Werkstoffen ausgelegt





Kleinstbohrer ohne Kühlkanäle

Artikel-Nr. 86400



P	M	K	N	S	H
•	•	•	○	○	

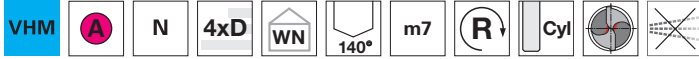

Ausspitzung $\geq \text{Ø } 0,500$ • Flächenanschliff • Hauptschneidenform gerade • geschliffener Schneidenabzug
 Bau- und Einsatzstähle • Automatenstähle, Vergütungsstähle • legierte Stähle bis 1200 N/mm² • rostfreie Stähle • Gusswerkstoffe

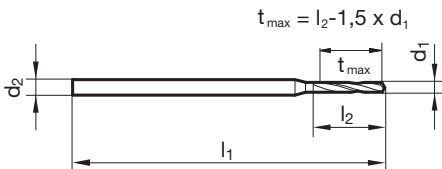

d1 mm	d2 h6 mm	l1 mm	l2 mm	d1 mm	d2 h6 mm	l1 mm	l2 mm
0,500	3,000	47,000	3,000	1,950	3,000	52,000	11,700
0,550	3,000	47,000	3,300	1,980	4,000	59,000	12,000
0,600	3,000	47,000	3,600	2,000	4,000	59,000	12,000
0,650	3,000	47,000	3,900	2,050	4,000	59,000	12,300
0,700	3,000	47,000	4,200	2,100	4,000	59,000	12,600
0,750	3,000	47,000	4,500	2,150	4,000	59,000	12,900
0,800	3,000	47,000	4,800	2,200	4,000	59,000	13,200
0,850	3,000	47,000	5,100	2,250	4,000	59,000	13,500
0,900	3,000	47,000	5,400	2,300	4,000	59,000	13,800
0,950	3,000	47,000	5,700	2,350	4,000	59,000	14,100
1,000	3,000	47,000	6,000	2,380	4,000	59,000	14,400
1,050	3,000	47,000	6,300	2,400	4,000	59,000	14,400
1,100	3,000	47,000	6,600	2,450	4,000	59,000	14,700
1,150	3,000	47,000	6,900	2,500	4,000	59,000	15,000
1,200	3,000	47,000	7,200	2,550	4,000	59,000	15,300
1,250	3,000	47,000	7,500	2,600	4,000	59,000	15,600
1,300	3,000	47,000	7,800	2,650	4,000	59,000	15,900
1,350	3,000	47,000	8,100	2,700	4,000	59,000	16,200
1,400	3,000	47,000	8,400	2,750	4,000	59,000	16,500
1,450	3,000	47,000	8,700	2,780	4,000	59,000	16,800
1,500	3,000	47,000	9,000	2,800	4,000	59,000	16,800
1,550	3,000	47,000	9,300	2,850	4,000	59,000	17,100
1,590	3,000	47,000	9,600	2,900	4,000	59,000	17,400
1,600	3,000	47,000	9,600	2,950	4,000	59,000	17,700
1,650	3,000	47,000	9,900	3,000	4,000	59,000	18,000
1,700	3,000	47,000	10,200				
1,750	3,000	47,000	10,500				
1,800	3,000	52,000	10,800				
1,850	3,000	52,000	11,100				
1,900	3,000	52,000	11,400				

VHM-Kleinstbohrer



Kleinstbohrer ohne Kühlkanäle

Artikel-Nr. 86401



P	M	K	N	S	H
•	•	•	○	○	

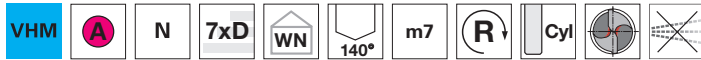

Ausspitzung $\geq \text{Ø } 0,500$ • Flächenanschliff • Hauptschneidenform gerade • geschliffener Schneidenabzug

Bau- und Einsatzstähle • Automatenstähle, Vergütungsstähle • legierte Stähle bis 1200 N/mm² • rostfreie Stähle • Gusswerkstoffe

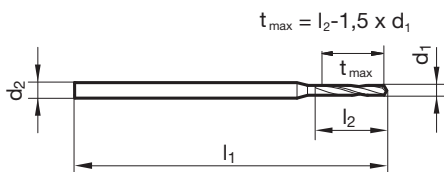

d1 mm	d2 h6 mm	l1 mm	l2 mm	d1 mm	d2 h6 mm	l1 mm	l2 mm
0,500	3,000	47,000	4,000	1,950	3,000	52,000	17,600
0,550	3,000	47,000	4,400	1,980	4,000	63,000	18,000
0,600	3,000	47,000	4,800	2,000	4,000	63,000	18,000
0,650	3,000	47,000	5,200	2,050	4,000	63,000	18,500
0,700	3,000	47,000	5,600	2,100	4,000	63,000	18,900
0,750	3,000	47,000	6,000	2,150	4,000	63,000	19,400
0,800	3,000	47,000	6,400	2,200	4,000	63,000	19,800
0,850	3,000	47,000	6,800	2,250	4,000	63,000	20,300
0,900	3,000	47,000	7,200	2,300	4,000	63,000	20,700
0,950	3,000	47,000	7,600	2,350	4,000	63,000	21,200
1,000	3,000	47,000	8,000	2,380	4,000	63,000	21,600
1,050	3,000	47,000	8,400	2,400	4,000	63,000	21,600
1,100	3,000	47,000	8,800	2,450	4,000	63,000	22,100
1,150	3,000	47,000	9,200	2,500	4,000	63,000	22,500
1,200	3,000	52,000	10,800	2,550	4,000	63,000	23,000
1,250	3,000	52,000	11,300	2,600	4,000	67,000	23,400
1,300	3,000	52,000	11,700	2,650	4,000	67,000	23,900
1,350	3,000	52,000	12,200	2,700	4,000	67,000	24,300
1,400	3,000	52,000	12,600	2,750	4,000	67,000	24,800
1,450	3,000	52,000	13,100	2,780	4,000	67,000	25,200
1,500	3,000	52,000	13,500	2,800	4,000	67,000	25,200
1,550	3,000	52,000	14,000	2,850	4,000	67,000	25,700
1,590	3,000	52,000	14,400	2,900	4,000	67,000	26,100
1,600	3,000	52,000	14,400	2,950	4,000	67,000	26,600
1,650	3,000	52,000	14,900	3,000	4,000	67,000	27,000
1,700	3,000	52,000	15,300				
1,750	3,000	52,000	15,800				
1,800	3,000	52,000	16,200				
1,850	3,000	52,000	16,700				
1,900	3,000	52,000	17,100				



Kleinstbohrer mit Kühlkanälen

Artikel-Nr. 86405



P	M	K	N	S	H
•	•	•	○	○	

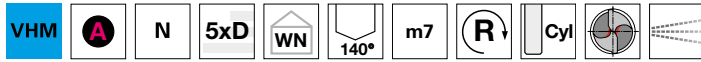

Ausspitzung $\geq \varnothing 1,400$ • Flächenanschliff • Hauptschneidenform gerade • geschliffener Schneidenabzug

Bau- und Einsatzstähle • Automatenstähle, Vergütungsstähle • legierte Stähle bis 1200 N/mm² • rostfreie Stähle • Gusswerkstoffe

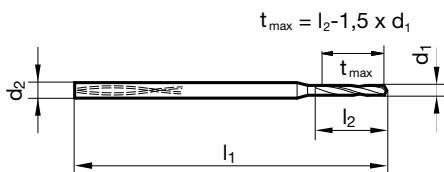

d1 mm	d2 h6 mm	l1 mm	l2 mm	d1 mm	d2 h6 mm	l1 mm	l2 mm
1,400	4,000	52,000	11,000	2,450	4,000	62,000	20,000
1,450	4,000	52,000	12,000	2,500	4,000	62,000	20,000
1,500	4,000	52,000	12,000	2,550	4,000	62,000	20,000
1,550	4,000	52,000	12,000	2,600	4,000	66,000	21,000
1,590	4,000	52,000	13,000	2,650	4,000	66,000	21,000
1,600	4,000	52,000	13,000	2,700	4,000	66,000	22,000
1,650	4,000	52,000	13,000	2,750	4,000	66,000	22,000
1,700	4,000	56,000	14,000	2,780	4,000	66,000	22,000
1,750	4,000	56,000	14,000	2,800	4,000	66,000	22,000
1,800	4,000	56,000	14,000	2,850	4,000	66,000	23,000
1,850	4,000	56,000	15,000	2,900	4,000	66,000	23,000
1,900	4,000	56,000	15,000	2,950	4,000	66,000	24,000
1,950	4,000	56,000	16,000	3,000	4,000	66,000	24,000
1,980	4,000	56,000	16,000				
2,000	4,000	56,000	16,000				
2,050	4,000	56,000	16,000				
2,100	4,000	62,000	17,000				
2,150	4,000	62,000	17,000				
2,200	4,000	62,000	18,000				
2,250	4,000	62,000	18,000				
2,300	4,000	62,000	18,000				
2,350	4,000	62,000	19,000				
2,380	4,000	62,000	19,000				
2,400	4,000	62,000	19,000				

VHM-Kleinstbohrer



Kleinstbohrer mit Kühlkanälen

Artikel-Nr. 86408



P	M	K	N	S	H
•	•	•	○	○	

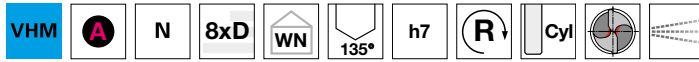

Ausspitzung $\geq \text{Ø } 1,400$ • Flächenanschliff • Hauptschneidenform gerade • geschliffener Schneidenabzug
 Bau- und Einsatzstähle • Automatenstähle, Vergütungsstähle • legierte Stähle bis 1200 N/mm² • rostfreie Stähle • Gusswerkstoffe

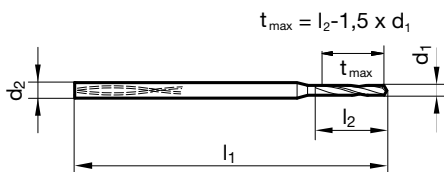

d1 mm	d2 h6 mm	l1 mm	l2 mm	d1 mm	d2 h6 mm	l1 mm	l2 mm
1,400	4,000	52,000	15,000	2,600	4,000	66,000	29,000
1,500	4,000	52,000	17,000	2,700	4,000	66,000	30,000
1,600	4,000	52,000	18,000	2,800	4,000	66,000	31,000
1,700	4,000	56,000	19,000	2,900	4,000	66,000	32,000
1,800	4,000	56,000	20,000	3,000	4,000	66,000	33,000
1,900	4,000	56,000	21,000				
2,000	4,000	56,000	22,000				
2,100	4,000	62,000	23,000				
2,200	4,000	62,000	24,000				
2,300	4,000	62,000	25,000				
2,400	4,000	62,000	26,000				
2,500	4,000	62,000	28,000				



Kleinstbohrer mit Kühlkanälen

Artikel-Nr. 86412



P	M	K	N	S	H
•	•	•	○	○	

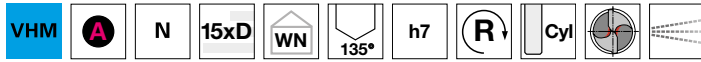

Ausspitzung $\geq \text{Ø } 1,400$ • Flächenanschliff • Hauptschneidenform gerade • geschliffener Schneidenabzug
 Bau- und Einsatzstähle • Automatenstähle, Vergütungsstähle • legierte Stähle bis 1200 N/mm² • rostfreie Stähle • Gusswerkstoffe

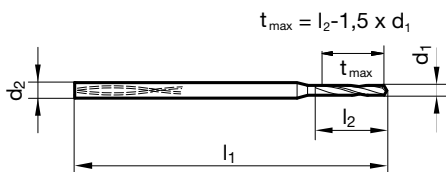

d1 mm	d2 h6 mm	l1 mm	l2 mm	d1 mm	d2 h6 mm	l1 mm	l2 mm
1,400	4,000	62,000	25,000	2,600	4,000	87,000	47,000
1,500	4,000	62,000	27,000	2,700	4,000	87,000	48,000
1,600	4,000	62,000	29,000	2,800	4,000	87,000	50,000
1,700	4,000	70,000	31,000	2,900	4,000	87,000	52,000
1,800	4,000	70,000	32,000	3,000	4,000	87,000	54,000
1,900	4,000	70,000	34,000				
2,000	4,000	70,000	36,000				
2,100	4,000	78,000	38,000				
2,200	4,000	78,000	40,000				
2,300	4,000	78,000	42,000				
2,400	4,000	78,000	44,000				
2,500	4,000	78,000	45,000				



ANWENDUNGSBEISPIEL PUMPE

Werkzeug-Typ	Kleinstbohrer
Artikel-Nr.	86412
Durchmesser	2,8 mm
Bohrtiefe	38 mm
Material	X6CrNiTi18-10
Kühlung	IK 80 bar
Schmierstoff	Emulsion
Maschine	BAZ
v_c	60 m/min
f	0,03 mm/U
Standweg	60 m

TS 100 T

▼ VORTEILE UND EIGENSCHAFTEN

- ▼ **spiralisierter Tieflochbohrer** für Bohrtiefen bis **40xD** in unlegierten und legierten Stählen, insbesondere auch in Kurbelwellenstahl
- ▼ optimierter Nutquerschnitt, maximaler Kühlkanalquerschnitt und blanke, besonders glatte Nuten führen zu einer **optimalen Spanabfuhr aus tiefen Bohrungen**
- ▼ **höchste Vorschübe und Schnittgeschwindigkeiten** führen zu einer deutlichen **Verkürzung der Fertigungszeiten**
- ▼ zusätzlich zum Lagerprogramm sind **Zwischenabmessungen** bei einer maximalen Bohrtiefe bis **40xD** bzw. einer maximalen **Gesamtlänge bis 500 mm** realisierbar
- ▼ **Sonderausführung** für die **Aluminiumbearbeitung** auf Anfrage erhältlich 



ALLGEMEINE STAHLBEABREITUNG BIS $\sim 1200 \text{ N/mm}^2$

▼ UNIVERSELLE ANWENDUNG

die **Werkzeuggeometrie** ist für den universellen Einsatz in nahezu allen Werkstoffen ausgelegt

Spezialauspitzung für präzise Bohrungen und geringen Mittenverlauf

maximaler Kühlkanalquerschnitt sichert eine effektive Schmiermittelversorgung der Schneide sowie eine ausgezeichnete Spanabfuhr

vier Führungsfasen für optimale Abstützung in der Bohrung

optimaler Nutquerschnitt sorgt im vorderen Werkzeugbereich für eine optimale Spanbildung und im hinteren Bereich für eine gute Spanabfuhr

polierte Nuten für perfekte Spanabfuhr – auch bei extremen Bohrtiefen





TS-Drills mit Innenkühlung

Artikel-Nr. 86509



P	M	K	N	S	H
•	•	•	○	○	○



Ausspitzung $\geq \text{Ø} 3,000$ • Kegelmantelanschliff • Kopfbeschichtung • Hauptschneidenform konkav • optimierter Nutquerschnitt
 • maximaler Kühlkanalquerschnitt • Kühlmitteldruck beachten
 Bau- und Einsatzstähle • Automatenstähle, Vergütungsstähle • legierte Stähle bis 1200 N/mm² • rostfreie Stähle • Gusswerkstoffe

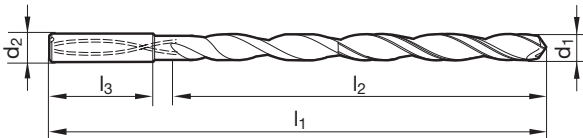

d1		d2 h6	l1	l2	l3	d1		d2 h6	l1	l2	l3
mm	inch	mm	mm	mm	mm	mm	inch	mm	mm	mm	mm
3,000		6,000	95,000	55,000	36,000	7,540	19/64	8,000	183,000	143,000	36,000
3,100		6,000	106,000	66,000	36,000	7,800		8,000	183,000	143,000	36,000
3,170	1/8	6,000	106,000	66,000	36,000	7,940	5/16	8,000	183,000	143,000	36,000
3,200		6,000	106,000	66,000	36,000	8,000		8,000	183,000	143,000	36,000
3,300		6,000	106,000	66,000	36,000	8,330	21/64	10,000	204,000	160,000	40,000
3,500		6,000	116,000	76,000	36,000	8,500		10,000	204,000	160,000	40,000
3,570	9/64	6,000	116,000	76,000	36,000	8,730	11/32	10,000	204,000	160,000	40,000
3,700		6,000	116,000	76,000	36,000	8,800		10,000	204,000	160,000	40,000
3,800		6,000	116,000	76,000	36,000	9,000		10,000	204,000	160,000	40,000
3,970	5/32	6,000	116,000	76,000	36,000	9,130	23/64	10,000	221,000	177,000	40,000
4,000		6,000	116,000	76,000	36,000	9,500		10,000	221,000	177,000	40,000
4,200		6,000	133,000	93,000	36,000	9,520	3/8	10,000	221,000	177,000	40,000
4,300		6,000	133,000	93,000	36,000	9,800		10,000	221,000	177,000	40,000
4,370	11/64	6,000	133,000	93,000	36,000	9,920	25/64	10,000	221,000	177,000	40,000
4,500		6,000	133,000	93,000	36,000	10,000		10,000	221,000	177,000	40,000
4,600		6,000	133,000	93,000	36,000	10,320	13/32	12,000	247,000	198,000	45,000
4,760	3/16	6,000	133,000	93,000	36,000	10,500		12,000	247,000	198,000	45,000
4,800		6,000	133,000	93,000	36,000	10,720	27/64	12,000	247,000	198,000	45,000
5,000		6,000	133,000	93,000	36,000	11,000		12,000	247,000	198,000	45,000
5,100		6,000	150,000	110,000	36,000	11,110	7/16	12,000	263,000	214,000	45,000
5,160	13/64	6,000	150,000	110,000	36,000	11,510	29/64	12,000	263,000	214,000	45,000
5,410		6,000	150,000	110,000	36,000	11,800		12,000	263,000	214,000	45,000
5,500		6,000	150,000	110,000	36,000	11,910	15/32	12,000	263,000	214,000	45,000
5,560	7/32	6,000	150,000	110,000	36,000	12,000		12,000	263,000	214,000	45,000
5,600		6,000	150,000	110,000	36,000	12,300	31/64	14,000	297,000	248,000	45,000
5,800		6,000	150,000	110,000	36,000	12,500		14,000	297,000	248,000	45,000
5,950	15/64	6,000	150,000	110,000	36,000	12,700	1/2	14,000	297,000	248,000	45,000
6,000		6,000	150,000	110,000	36,000	13,000		14,000	297,000	248,000	45,000
6,300		8,000	167,000	127,000	36,000	13,100	33/64	14,000	297,000	248,000	45,000
6,350	1/4	8,000	167,000	127,000	36,000	13,490	17/32	14,000	297,000	248,000	45,000
6,500		8,000	167,000	127,000	36,000	13,890	35/64	14,000	297,000	248,000	45,000
6,750	17/64	8,000	167,000	127,000	36,000	14,000		14,000	297,000	248,000	45,000
6,800		8,000	167,000	127,000	36,000	14,290	9/16	16,000	333,000	281,000	48,000
7,000		8,000	167,000	127,000	36,000	15,000		16,000	333,000	281,000	48,000
7,140	9/32	8,000	183,000	143,000	36,000	15,870	5/8	16,000	333,000	281,000	48,000
7,500		8,000	183,000	143,000	36,000	16,000		16,000	333,000	281,000	48,000

TS 100 T



TS-Drills mit Innenkühlung

Artikel-Nr. 86511



P	M	K	N	S	H
•	•	•	○	○	○



- Ausspitzung $\geq \text{Ø } 3,000$ • Kegelmantelanschliff • Kopfbeschichtung • Hauptschneidenform konkav • optimierter Nutquerschnitt
 • maximaler Kühlkanalquerschnitt • Kühlmitteldruck beachten
 Bau- und Einsatzstähle • Automatenstähle, Vergütungsstähle • legierte Stähle bis 1200 N/mm² • rostfreie Stähle • Gusswerkstoffe

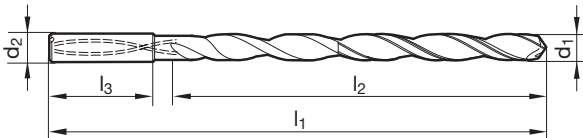

d1		d2 h6	l1	l2	l3	d1		d2 h6	l1	l2	l3
mm	inch	mm	mm	mm	mm	mm	inch	mm	mm	mm	mm
3,000		6,000	110,000	70,000	36,000	7,940	5/16	8,000	223,000	183,000	36,000
3,100		6,000	123,000	83,000	36,000	8,000		8,000	223,000	183,000	36,000
3,170	1/8	6,000	123,000	83,000	36,000	8,330	21/64	10,000	249,000	205,000	40,000
3,200		6,000	123,000	83,000	36,000	8,500		10,000	249,000	205,000	40,000
3,300		6,000	123,000	83,000	36,000	8,730	11/32	10,000	249,000	205,000	40,000
3,500		6,000	136,000	96,000	36,000	8,800		10,000	249,000	205,000	40,000
3,570	9/64	6,000	136,000	96,000	36,000	9,000		10,000	249,000	205,000	40,000
3,700		6,000	136,000	96,000	36,000	9,130	23/64	10,000	271,000	227,000	40,000
3,800		6,000	136,000	96,000	36,000	9,520	3/8	10,000	271,000	227,000	40,000
3,970	5/32	6,000	136,000	96,000	36,000	9,920	25/64	10,000	271,000	227,000	40,000
4,000		6,000	136,000	96,000	36,000	10,000		10,000	271,000	227,000	40,000
4,200		6,000	158,000	118,000	36,000	10,200		12,000	302,000	253,000	45,000
4,300		6,000	158,000	118,000	36,000	10,320	13/32	12,000	302,000	253,000	45,000
4,370	11/64	6,000	158,000	118,000	36,000	10,500		12,000	302,000	253,000	45,000
4,500		6,000	158,000	118,000	36,000	10,720	27/64	12,000	302,000	253,000	45,000
4,600		6,000	158,000	118,000	36,000	11,000		12,000	302,000	253,000	45,000
4,760	3/16	6,000	158,000	118,000	36,000	11,110	7/16	12,000	323,000	274,000	45,000
4,800		6,000	158,000	118,000	36,000	11,510	29/64	12,000	323,000	274,000	45,000
5,000		6,000	158,000	118,000	36,000	11,800		12,000	323,000	274,000	45,000
5,100		6,000	180,000	140,000	36,000	11,910	15/32	12,000	323,000	274,000	45,000
5,160	13/64	6,000	180,000	140,000	36,000	12,000		12,000	323,000	274,000	45,000
5,410		6,000	180,000	140,000	36,000	12,300	31/64	14,000	367,000	318,000	45,000
5,500		6,000	180,000	140,000	36,000	12,500		14,000	367,000	318,000	45,000
5,560	7/32	6,000	180,000	140,000	36,000	12,700	1/2	14,000	367,000	318,000	45,000
5,800		6,000	180,000	140,000	36,000	13,000		14,000	367,000	318,000	45,000
5,950	15/64	6,000	180,000	140,000	36,000	13,100	33/64	14,000	367,000	318,000	45,000
6,000		6,000	180,000	140,000	36,000	13,490	17/32	14,000	367,000	318,000	45,000
6,350	1/4	8,000	202,000	162,000	36,000	13,890	35/64	14,000	367,000	318,000	45,000
6,500		8,000	202,000	162,000	36,000	14,000		14,000	367,000	318,000	45,000
6,750	17/64	8,000	202,000	162,000	36,000	14,290	9/16	16,000	413,000	361,000	48,000
6,800		8,000	202,000	162,000	36,000	15,000		16,000	413,000	361,000	48,000
7,000		8,000	202,000	162,000	36,000	15,870	5/8	16,000	413,000	361,000	48,000
7,140	9/32	8,000	223,000	183,000	36,000	16,000		16,000	413,000	361,000	48,000
7,500		8,000	223,000	183,000	36,000						
7,540	19/64	8,000	223,000	183,000	36,000						
7,800		8,000	223,000	183,000	36,000						

TS 100 T



TS-Drills mit Innenkühlung

Artikel-Nr. 86512



P	M	K	N	S	H
•	•	•	○	○	○

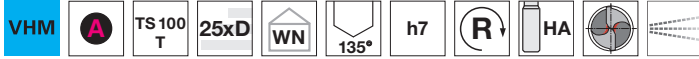

Ausspitzung $\geq \text{Ø } 3,000$ • Kegelmantelanschliff • Kopfbeschichtung • Hauptschneidenform konkav • optimierter Nutquerschnitt
 • maximaler Kühlkanalquerschnitt • Kühlmitteldruck beachten
 Bau- und Einsatzstähle • Automatenstähle, Vergütungsstähle • legierte Stähle bis 1200 N/mm² • rostfreie Stähle • Gusswerkstoffe

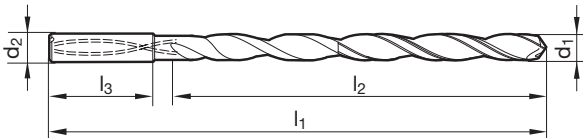

d1		d2 h6	l1	l2	l3	d1		d2 h6	l1	l2	l3
mm	inch	mm	mm	mm	mm	mm	inch	mm	mm	mm	mm
3,000		6,000	125,000	85,000	36,000	7,940	5/16	8,000	263,000	223,000	36,000
3,100		6,000	141,000	101,000	36,000	8,000		8,000	263,000	223,000	36,000
3,170	1/8	6,000	141,000	101,000	36,000	8,330	21/64	10,000	294,000	250,000	40,000
3,200		6,000	141,000	101,000	36,000	8,500		10,000	294,000	250,000	40,000
3,300		6,000	141,000	101,000	36,000	8,730	11/32	10,000	294,000	250,000	40,000
3,500		6,000	156,000	116,000	36,000	8,800		10,000	294,000	250,000	40,000
3,570	9/64	6,000	156,000	116,000	36,000	9,000		10,000	294,000	250,000	40,000
3,700		6,000	156,000	116,000	36,000	9,130	23/64	10,000	321,000	277,000	40,000
3,800		6,000	156,000	116,000	36,000	9,520	3/8	10,000	321,000	277,000	40,000
3,970	5/32	6,000	156,000	116,000	36,000	9,920	25/64	10,000	321,000	277,000	40,000
4,000		6,000	156,000	116,000	36,000	10,000		10,000	321,000	277,000	40,000
4,200		6,000	183,000	143,000	36,000	10,320	13/32	12,000	359,000	310,000	45,000
4,300		6,000	183,000	143,000	36,000	10,720	27/64	12,000	359,000	310,000	45,000
4,370	11/64	6,000	183,000	143,000	36,000	11,000		12,000	359,000	310,000	45,000
4,500		6,000	183,000	143,000	36,000	11,110	7/16	12,000	386,000	337,000	45,000
4,600		6,000	183,000	143,000	36,000	11,510	29/64	12,000	386,000	337,000	45,000
4,760	3/16	6,000	183,000	143,000	36,000	11,910	15/32	12,000	386,000	337,000	45,000
4,800		6,000	183,000	143,000	36,000	12,000		12,000	386,000	337,000	45,000
5,000		6,000	183,000	143,000	36,000	12,300	31/64	14,000	437,000	388,000	45,000
5,100		6,000	210,000	170,000	36,000	12,700	1/2	14,000	437,000	388,000	45,000
5,160	13/64	6,000	210,000	170,000	36,000	13,000		14,000	437,000	388,000	45,000
5,410		6,000	210,000	170,000	36,000	13,100	33/64	14,000	437,000	388,000	45,000
5,500		6,000	210,000	170,000	36,000	13,490	17/32	14,000	437,000	388,000	45,000
5,560	7/32	6,000	210,000	170,000	36,000	13,890	35/64	14,000	437,000	388,000	45,000
5,800		6,000	210,000	170,000	36,000	14,000		14,000	437,000	388,000	45,000
5,950	15/64	6,000	210,000	170,000	36,000	14,290	9/16	16,000	493,000	441,000	48,000
6,000		6,000	210,000	170,000	36,000	15,000		16,000	493,000	441,000	48,000
6,300		8,000	237,000	197,000	36,000	15,870	5/8	16,000	493,000	441,000	48,000
6,350	1/4	8,000	237,000	197,000	36,000	16,000		16,000	493,000	441,000	48,000
6,500		8,000	237,000	197,000	36,000						
6,750	17/64	8,000	237,000	197,000	36,000						
6,800		8,000	237,000	197,000	36,000						
7,000		8,000	237,000	197,000	36,000						
7,140	9/32	8,000	263,000	223,000	36,000						
7,500		8,000	263,000	223,000	36,000						
7,540	19/64	8,000	263,000	223,000	36,000						

TS 100 T



TS-Drills mit Innenkühlung

Artikel-Nr. 86513



P	M	K	N	S	H
•	•	•	○	○	○



- Ausspitzung $\geq \text{Ø } 3,000$ • Kegelmantelanschliff • Kopfbeschichtung • Hauptschneidenform konkav • optimierter Nutquerschnitt
- maximaler Kühlkanalquerschnitt • Kühlmitteldruck beachten
- Bau- und Einsatzstähle • Automatenstähle, Vergütungsstähle • legierte Stähle bis 1200 N/mm^2 • rostfreie Stähle • Gusswerkstoffe

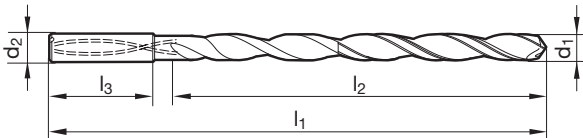

d1		d2 h6	l1	l2	l3	d1		d2 h6	l1	l2	l3
mm	inch	mm	mm	mm	mm	mm	inch	mm	mm	mm	mm
3,000		6,000	140,000	100,000	36,000	7,500		8,000	303,000	263,000	36,000
3,100		6,000	158,000	118,000	36,000	7,540	19/64	8,000	303,000	263,000	36,000
3,170	1/8	6,000	158,000	118,000	36,000	7,940	5/16	8,000	303,000	263,000	36,000
3,200		6,000	158,000	118,000	36,000	8,000		8,000	303,000	263,000	36,000
3,300		6,000	158,000	118,000	36,000	8,330	21/64	10,000	339,000	295,000	40,000
3,500		6,000	176,000	136,000	36,000	8,500		10,000	339,000	295,000	40,000
3,570	9/64	6,000	176,000	136,000	36,000	8,730	11/32	10,000	339,000	295,000	40,000
3,700		6,000	176,000	136,000	36,000	8,800		10,000	339,000	295,000	40,000
3,800		6,000	176,000	136,000	36,000	9,000		10,000	339,000	295,000	40,000
3,970	5/32	6,000	176,000	136,000	36,000	9,130	23/64	10,000	371,000	327,000	40,000
4,000		6,000	176,000	136,000	36,000	9,520	3/8	10,000	371,000	327,000	40,000
4,200		6,000	208,000	168,000	36,000	9,920	25/64	10,000	371,000	327,000	40,000
4,370	11/64	6,000	208,000	168,000	36,000	10,000		10,000	371,000	327,000	40,000
4,500		6,000	208,000	168,000	36,000	10,320	13/32	12,000	412,000	363,000	45,000
4,760	3/16	6,000	208,000	168,000	36,000	10,720	27/64	12,000	412,000	363,000	45,000
5,000		6,000	208,000	168,000	36,000	11,000		12,000	412,000	363,000	45,000
5,100		6,000	240,000	200,000	36,000	11,110	7/16	12,000	443,000	394,000	45,000
5,160	13/64	6,000	240,000	200,000	36,000	11,510	29/64	12,000	443,000	394,000	45,000
5,410		6,000	240,000	200,000	36,000	11,910	15/32	12,000	443,000	394,000	45,000
5,500		6,000	240,000	200,000	36,000	12,000		12,000	443,000	394,000	45,000
5,560	7/32	6,000	240,000	200,000	36,000	12,300	31/64	14,000	507,000	458,000	45,000
5,950	15/64	6,000	240,000	200,000	36,000	12,700	1/2	14,000	507,000	458,000	45,000
6,000		6,000	240,000	200,000	36,000	13,000		14,000	507,000	458,000	45,000
6,300		8,000	272,000	232,000	36,000	13,100	33/64	14,000	507,000	458,000	45,000
6,350	1/4	8,000	272,000	232,000	36,000	13,490	17/32	14,000	507,000	458,000	45,000
6,500		8,000	272,000	232,000	36,000	13,890	35/64	14,000	507,000	458,000	45,000
6,750	17/64	8,000	272,000	232,000	36,000	14,000		14,000	507,000	458,000	45,000
6,800		8,000	272,000	232,000	36,000						
7,000		8,000	272,000	232,000	36,000						
7,140	9/32	8,000	303,000	263,000	36,000						



TS-Drills mit Innenkühlung

Artikel-Nr. 86514



P	M	K	N	S	H
•	•	•	○	○	○



- Ausspitzung $\geq \text{Ø } 3,000$ • Kegelmantelanschliff • Kopfbeschichtung • Hauptschneidenform konkav • optimierter Nutquerschnitt
- maximaler Kühlkanalquerschnitt • Kühlmitteldruck beachten
- Bau- und Einsatzstähle • Automatenstähle, Vergütungsstähle • legierte Stähle bis 1200 N/mm^2 • rostfreie Stähle • Gusswerkstoffe

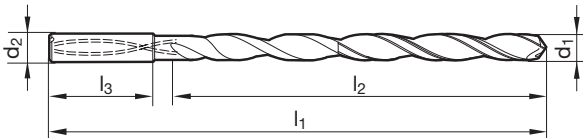

d1	inch	d2 h6	l1	l2	l3	d1	inch	d2 h6	l1	l2	l3
mm		mm	mm	mm	mm	mm		mm	mm	mm	mm
3,000		6,000	170,000	130,000	36,000	5,500		6,000	280,000	240,000	36,000
3,100		6,000	193,000	153,000	36,000	5,560	7/32	6,000	300,000	260,000	36,000
3,170	1/8	6,000	193,000	153,000	36,000	5,950	15/64	6,000	300,000	260,000	36,000
3,200		6,000	193,000	153,000	36,000	6,000		6,000	300,000	260,000	36,000
3,300		6,000	193,000	153,000	36,000	6,300		8,000	322,000	282,000	36,000
3,500		6,000	193,000	153,000	36,000	6,350	1/4	8,000	322,000	282,000	36,000
3,570	9/64	6,000	216,000	176,000	36,000	6,500		8,000	322,000	282,000	36,000
3,800		6,000	216,000	176,000	36,000	6,750	17/64	8,000	342,000	302,000	36,000
3,970	5/32	6,000	216,000	176,000	36,000	6,800		8,000	342,000	302,000	36,000
4,000		6,000	216,000	176,000	36,000	7,000		8,000	342,000	302,000	36,000
4,200		6,000	238,000	198,000	36,000	7,140	9/32	8,000	363,000	323,000	36,000
4,370	11/64	6,000	238,000	198,000	36,000	7,500		8,000	363,000	323,000	36,000
4,500		6,000	238,000	198,000	36,000	7,540	19/64	8,000	383,000	343,000	36,000
4,760	3/16	6,000	258,000	218,000	36,000	7,940	5/16	8,000	383,000	343,000	36,000
5,000		6,000	258,000	218,000	36,000	8,000		8,000	383,000	343,000	36,000
5,100		6,000	280,000	240,000	36,000	8,500		10,000	409,000	365,000	40,000
5,160	13/64	6,000	280,000	240,000	36,000	9,000		10,000	429,000	386,000	40,000
5,410		6,000	280,000	240,000	36,000	10,000		10,000	471,000	427,000	40,000

EINSATZEMPFEHLUNGEN

DIE BESCHICHTUNGEN



F FIRE-/nanoFIRE-Schicht

- ▼ Optisches Kennzeichen: Farbe Schwarzviolett
- ▼ Multilayer-TiAlN-Schicht mit gradientem Aufbau. Allroundschicht mit min. 2 mal höherer Leistung als TiN. Vereint die Vorteile von TiN, TiAlN und TiCN. Exzellente, sozusagen „feuerfeste“ Wärmeisolierung. Hohe Zähigkeit. FIRE plus MolyGlide – die ideale Kombination und Voraussetzung für Trocken- und HSC-Bearbeitung.

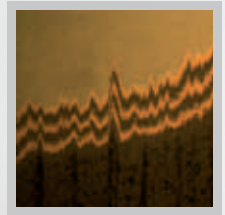

A AlTiN-Schicht (Aluminiumtitannitrid)

a AlTiN nano-Schicht (Aluminiumtitannitrid)

- ▼ Optisches Kennzeichen: Farbe Schwarzviolett
- ▼ Die bewährte Beschichtung auf TiAlN-Basis aus unserem Hause wurde kontinuierlich weiterentwickelt. Die optimierten strukturellen, chemischen und mechanischen Eigenschaften der AlTiN-Schicht führen zu einer extrem hohen Warmhärte, einer sehr guten Oxidationsbeständigkeit sowie einer exzellenten Schichthaftung. Diese Schicht eignet sich nur in Verbindung mit Hartmetall für die Bearbeitung schwer zerspanbarer Materialien wie zum Beispiel Inconel und gehärteten Stählen sowie für die Hartzerspannung (> 52 HRC) und die HSC-Bearbeitung. Sehr gut geeignet für die Bearbeitung von rostfreien Stählen.

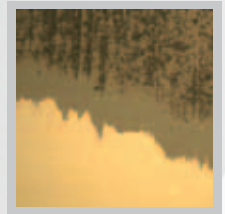

A TiAlN-Schicht (Titanaluminiumnitrid)

- ▼ Optisches Kennzeichen: Farbe Schwarzviolett
- ▼ Spezierschicht für Zerspanungsaufgaben in abrasiven Werkstoffen (Guss, AlSi) und/oder hohen Temperaturbelastungen, also bei Einsätzen ohne Kühlung oder eingeschränkter Kühlmöglichkeit, wie bei tiefen Bohrungen oder kleinen Durchmessern. Speziell hier gilt, dass erst bei höheren Schnittdaten die Schicht zu deutlichen Leistungsverbesserungen führt.

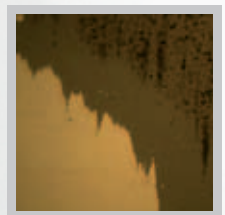

Y TiAlSiN-Schicht

- ▼ Optisches Kennzeichen: Farbe Bronzerot
- ▼ Hochharte, warmfeste Mehrlagenschicht speziell für die Bearbeitung hochfester sowie gehärteter Stähle und von Gusseisen. Dank ihrer Nanocomposite-Struktur mit einem Schichtaufbau aus TiAlN und SiN erreicht sie die extreme Härte von 5500 HV.



ANWENDUNGSEMPFEHLUNGEN

TS-Drills

Allgemeine Hinweise:

Enorm wichtig ist, dass aus Sicherheitsgründen kein Bohrer ohne Abstützung mit einer höheren Drehzahl als $n = 6.000 \text{ U/min}$ frei drehen darf. Die Zentrifugalkräfte könnten sonst die langen Werkzeuge schon vor dem Erreichen der Werkstückoberfläche brechen!

Einsatzhinweise für den 7xD-, 10xD- und 12xD-Bohrer:

Für Bohrtiefen $\geq 7xD$ sind grundsätzlich Pilotbohrungen zu setzen.

1. Die Pilotbohrung kann mit einem kurzen, steifen Bohrer hergestellt werden, dessen Durchmesser $0,01-0,02 \text{ mm}$ größer ist als der Durchmesser des TS-Drills. Tiefe der Pilotbohrung $1xD$.
2. Alternativ kann der TS-Drill die Pilotbohrung selbst herstellen. Hierfür sind die Schnittgeschwindigkeit und der Vorschub um $30-40\%$ zu reduzieren.

VHM-Kleinstbohrer

Pilotbohrung

Beim Einsatz des VHM-Kleinstbohrers $15xD$ empfehlen wir die Herstellung einer Pilotbohrung mit $1xD$ bis $2xD$ Tiefe. Der VHM-Kleinstbohrer $4xD$ ist optimal für diese Pilotbohrung geeignet. Sein Spitzenwinkel und seine Durchmesserertoleranz sind optimal darauf abgestimmt.

Zentrieren

Um bei den VHM-Kleinstbohrern ab $8xD$ Bohrtiefe die volle Leistung zu erreichen, empfehlen wir das Zentrieren. Hierzu kann der VHM-Kleinstbohrer bis $4xD$, Artikel-Nr. 86400, verwendet werden. Der Zentrierdurchmesser sollte ca. $2/3xD$ haben.

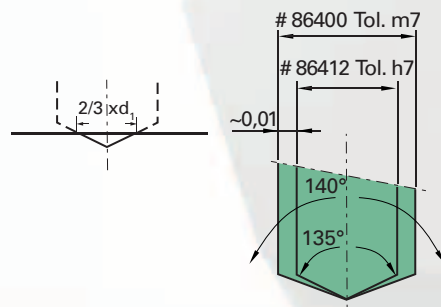

Filterqualität

Aufgrund der extrem kleinen Kühlkanaldurchmesser empfehlen wir beim Einsatz der VHM-Kleinstbohrer mit Innenkühlung eine ständige Überwachung der Filterqualität des Kühlschmiermittels.



Einsatzempfehlungen für TS-Drills

Artikel-Nr. HA	HA
Artikel-Nr. HE	HE
Norm/DIN	
Schneidstoff	
Oberfläche	
Typ	
Innenkühlung	
Programm Seite	

Allgemeine Hinweise für VHM-Bohrer:

Leistungsstarke Maschinen, spielarme Spindeln, fluchtungsgenaue Werkzeugaufnahmen, Rundlauffehler der Werkzeuge im eingespannten Zustand max. 0,02 mm, hohe Kühlmitteldrücke. Wir empfehlen die Anwendung von Hydraulik-Dehnspannfuttern oder Schrumpffuttern.

Hinweise zur Kühlung für VHM-Bohrer:

Wir empfehlen Kühl schmierung durch Emulsion oder Öl. Alternativ kann unter bestimmten Voraussetzungen auch mit Luftkühlung gearbeitet werden. Statt Luftkühlung würden wir jedoch immer den Einsatz unter MMS-Bedingungen bevorzugen, für den die Werkzeuge besonders geeignet sind.

Bei MMS-Einsatz empfehlen wir die Verwendung des kegeligen MMS-Schaftendes sowie der Hartner MMS-Einbauteile. Unser Außendienst berät Sie gerne.

Werkzeuge mit fett gesetzter Vorschubreihen-Nr. sind bevorzugt auszuwählen.

Bohrer-Ø mm	Vorschubreihen-Code								
	1	2	3	4	5	6	7	8	9
	f (mm/U)								
2,50	0,025	0,032	0,040	0,050	0,063	0,080	0,100	0,125	0,160
3,15	0,032	0,040	0,050	0,063	0,080	0,100	0,125	0,160	0,160
4,00	0,040	0,050	0,063	0,080	0,100	0,125	0,160	0,200	0,200
5,00	0,040	0,050	0,063	0,080	0,100	0,125	0,160	0,200	0,250
6,30	0,050	0,063	0,080	0,100	0,125	0,160	0,200	0,250	0,315
8,00	0,063	0,080	0,100	0,125	0,160	0,200	0,250	0,315	0,315
10,00	0,080	0,100	0,125	0,160	0,200	0,250	0,315	0,400	0,400
12,50	0,080	0,100	0,125	0,160	0,200	0,250	0,315	0,400	0,500
16,00	0,100	0,125	0,160	0,200	0,250	0,315	0,400	0,500	0,630
20,00	0,125	0,160	0,200	0,250	0,315	0,400	0,500	0,630	0,630
25,00	0,160	0,200	0,250	0,315	0,400	0,500	0,630	0,800	0,800

Kühlmittel:

- Emulsion
- Öl
- Luft

Werkstoffgruppe	Werkstoffbeispiele, neue Bezeichnung (in Klammern alte Bezeichnung) Fettgedruckte Zahlen = Werkstoff-Nr. nach DIN EN	Zugfestigkeit MPa (N/mm ²)	Härte	Kühl- mittel
Allgemeine Baustähle	1.0035 S185(St33), 1.0486 P275N(StE285), 1.0345 P235GH(H1), 1.0425 P265GH(H2) 1.0050 E295 (St50-2), 1.0070 E360 (St70-2), 1.8937 P500NH (WStE500)	≤500 ≤1000		○
Automatenstähle	1.0718 11SMnPb30 (9SMnPb28), 1.0736 11SMn37 (9SMn36) 1.0727 46S20 (45S20), 1.0728 (60S20), 1.0757 46SPb20 (45SPb20)	≤850 ≤1000		○
Unlegierte Vergütungsstähle	1.0402 C22, 1.1178 C30E (Ck30) 1.0503 C45, 1.1191 C45E (Ck45) 1.0601 C60, 1.1221 C60E (Ck60)	≤700 ≤850 ≤1000		○
Legierte Vergütungsstähle	1.5131 50MnSi4, 1.7003 38Cr2, 1.7030 28Cr4 1.5710 36NiCr6, 1.7035 41Cr4, 1.7225 42CrMo4	≤1000 ≤1400		○
Unlegierte Einsatzstähle	1.0301 (C10), 1.1121 C10E (Ck10)	≤850		○
Legierte Einsatzstähle	1.7276 10CrMo11, 1.5125 11MnSi6 1.5752 15NiCr13, 1.7131 16MnCr5, 1.7264 20CrMo5	≤1000 ≤1400		●
Nitrierstähle	1.8504 34CrAl6 1.8519 31CrMoV9, 1.8550 34CrAlNi7	≤1000 ≤1400		●
Werkzeugstähle	1.1750 C75W, 1.2067 102Cr6, 1.2307 29CrMoV9 1.2080 X210Cr12, 1.2083 X42Cr13, 1.2419 105WCr6, 1.2767 X45NiCrMo4	≤850 ≤1400		○
Schnellarbeitsstähle	1.3243 S 6-5-2-5, 1.3343 S 6-5-2, 1.3344 S 6-5-3	≤1400		●
Federstähle	1.5026 55Si7, 1.7176 55Cr3, 1.8159 51CrV4 (51CrV4)		≤350 HB	●
Gehärtete Stähle	-		≤48 HRC ≤66 HRC	●
Rostfreie Stähle, geschwefelt austenitisch martensitisch	1.4005 X12CrS13, 1.4104 X14CrMoS17, 1.4105 X6CrMoS17, 1.4305 X8CrNiS18-9 1.4301 X5CrNi18-10 (V2A), 1.4541 X6CrNiTi18-10, 1.4571 X6CrNiMoTi 17-12-2 (V4A) 1.4057 X20CrNi172 (X17CrNi16-2), 1.4122 X39CrMo17-1, 1.4521 X2CrMoTi18-2	≤900 ≤1100 ≤1500		●
Gusseisen	0.6010 EN-GJL-100 (GG10), 0.6020 EN-GJL-200 (GG20) 0.6025 EN-GJL-250 (GG25), 0.6035 EN-GJL-350 (GG35)		≤240 HB ≤350 HB	○
Kugelgraphit- und Temperguss	0.7050 EN-GJS-500-7 (GGG50), 0.8035 EN-GJMw-350-4 (GTW35) 0.7070 EN-GJS-700-2 (GGG70), 0.8170 EN-GJMB-700-2 (GTS70)		≤240 HB ≤350 HB	○
Hartguss	-		≤350 HB	○
Neue Gusswerkstoffe GGV	EN-GJV250 (GGV25), EN-GJV350 (GGV35) EN-GJV400 (GGV40), EN-GJV500 (GGV50), SiMo 6		≤220 HB ≤300 HB	○
Neue Gusswerkstoffe ADI	EN-GJS-800-8 (ADI800), EN-GJS-1000-5 (ADI1000) EN-GJS-1200-2 (ADI1200), EN-GJS-1400-1 (ADI1400)	≤1000 ≤1400		○
Sonderlegierungen	Nimonic, Inconel, Monel, Hastelloy	≤2000		●
Titan und Titan-Legierungen	3.7024 Ti99,5, 3.7114 TiAl5Sn2,5, 3.7124 TiCu2 3.7154 TiAl6Zr5, 3.7165 TiAl6V4, 3.7184 TiAl4Mo4Sn2,5, - TiAl8Mo1V1	≤850 ≤1400		●
Aluminium und Al-Legierungen	3.0255 Al99,5, 3.2315 AlMgSi1, 3.3515 AlMg1	≤400		○
Al-Knetlegierungen	3.0615 AlMgSiPb, 3.1325 AlCuMg1, 3.3245 AlMg3Si, 3.4365 AlZnMgCu1,5	≤650		○
Al-Gusslegierungen ≤ 10 % Si	3.2131 G-AlSi5Cu1, 3.2153 G-AlSi7Cu3, 3.2573 G-AlSi9	≤600		○
≤ 24 % Si	3.2581 G-AlSi12, 3.2583 G-AlSi12Cu, - G-AlSi12CuNiMg	≤600		○
Magnesium-Legierungen	3.5200 MgMn2, 3.5812.05 G-MgAl8Zn1, 3.5612.05 G-MgAl6Zn1	≤400		○
Kupfer, niedriglegiert	2.0070 SE-Cu, 2.1020 CuSn6, 2.1096 G-CuSn5ZnPb	≤600		○
Messing, kurzspanend	2.0380 CuZn39Pb2, 2.0401 CuZn39Pb3, 2.0410 CuZn43Pb2	≤600		○
langspanend	2.0250 CuZn20, 2.0280 CuZn33, 2.0332 CuZn37Pb0,5	≤600		○
Bronzen, kurzspanend	2.1090 CuSn7ZnPb, 2.1170 CuPb5Sn5, 2.1176 CuPb10Sn 2.0790 CuNi18Zn19Pb	≤600 ≤850		○
Bronzen, langspanend	2.0916 CuAl5, 2.0960 CuAl9Mn, 2.1050 CuSn10 2.0980 CuAl11Ni, 2.1247 CuBe2	≤850 ≤1000		○
Kunststoffe, duroplastisch	Epoxidharz, Resopal, Pertinax, Moltopren	≤150		○
thermoplastisch	Plexiglas, Hostalen, Novodur, Makralon	≤100		○
aramidfaserverstärkt	Kevlar	≤1000		○
glas-/kohlefaserverstärkt	GFK/CFK	≤1000		○



HARTNER

≤3xD

89413
89402
6537K
VHM
FIRE
TS 100 U
ohne IK
10

89410
89415
6537K
VHM
FIRE
TS 100 U
mit IK
14

89450
89550
6537K
VHM
AlTiN nano
TS 100 INOX
mit IK
24

89422
6537K
VHM
TiAlSiN
TS 100 H
ohne IK
50

89423
89424
6537K
VHM
TiAlSiN
TS 100 H
mit IK
52

≤4xD

89292
WN
VHM
blank
TS 150 GG
mit IK
36

≤5xD

89414
89417
6537L
VHM
FIRE
TS 100 U
ohne IK
12

89411
89408
6537L
VHM
FIRE
TS 100 U
mit IK
16



v _c m/min	VR-Code	v _c m/min	VR-Code	v _c m/min	VR-Code	v _c m/min	VR-Code	v _c m/min	VR-Code	v _c m/min	VR-Code	v _c m/min	VR-Code	v _c m/min	VR-Code
130	7	145	7			130	7	145	7	130	7	145	7	145	7
110	6	120	6			110	6	120	6			110	6	120	6
145	8	170	8			145	8	170	8			145	8	170	8
110	7	145	8			110	7	145	8			110	7	145	8
120	7	130	8			120	7	130	8			120	7	130	8
110	7	125	7			110	7	125	7			110	7	125	7
105	7	120	7			105	7	120	7			105	7	120	7
105	7	120	7			105	7	120	7			105	7	120	7
100	6	105	7			100	6	105	7			100	6	105	7
130	8	145	8			130	8	145	8			130	8	145	8
120	7	120	7			120	7	120	7			120	7	120	7
85	5	85	5			85	5	85	5			85	5	85	5
100	6	110	7			100	6	110	7			100	6	110	7
90	5	105	5			90	5	105	5			90	5	105	5
65	6	80	6			65	6	80	6			65	6	80	6
55	5	65	5			55	5	65	5			55	5	65	5
		60	4			55	4	60	4					60	5
45	3	60	3			45	3	60	3			45	3	60	3
40	1	55	3			40	1	55	3			40	1	55	2
20	1	35	2			20	1	35	2			20	1	35	2
40	2	60	5	80	5	40	2					40	2	60	5
15	1	55	2	60	2-3	15	1					15	1	55	5
35	2	45	5	80	5	35	2					35	2	45	5
210	8	210	9							120	7	210	8	210	9
155	8	160	9							100	7	155	8	160	9
155	7	140	9							90	7	155	7	140	9
125	7	130	8							80	7	125	7	130	8
35	3	40	3							40	2	35	3	40	3
25	4	35	4	30	4	25	4	35	4			25	4	35	4
15	1	45	4	45	4	15	1	45	4			15	1	45	4
15	1	40	3	40	3	15	1	40	3			15	1	40	3
260	9	310	9							410	9	260	9	310	9
260	9	310	9							410	9	260	9	310	9
220	8	260	9							380	9	220	9	260	9
180	8	220	9							330	9	180	8	220	9
260	8	280	8									260	8	280	8
105	7	125	7									105	7	125	7
270	8	325	8							280	9	270	8	325	8
180	7	220	7									180	7	220	7
105	6	125	7							110	6	105	6	125	7
85	6	105	6							80	5	85	6	105	6
80	5	90	6									80	5	90	6
60	5	80	6									60	5	80	6



Einsatzempfehlungen für TS-Drills

Artikel-Nr. HA	HA
Artikel-Nr. HE	HE
Norm/DIN	
Schneidstoff	
Oberfläche	
Typ	
Innenkühlung	
Programm Seite	

Allgemeine Hinweise für VHM-Bohrer:

Leistungsstarke Maschinen, spielarme Spindeln, fluchtungsgenaue Werkzeugaufnahmen, Rundlauffehler der Werkzeuge im eingespannten Zustand max. 0,02 mm, hohe Kühlmitteldrücke. Wir empfehlen die Anwendung von Hydraulik-Dehnspannfuttern oder Schrumpffuttern.

Hinweise zur Kühlung für VHM-Bohrer:

Wir empfehlen Kühl schmierung durch Emulsion oder Öl. Alternativ kann unter bestimmten Voraussetzungen auch mit Luftkühlung gearbeitet werden. Statt Luftkühlung würden wir jedoch immer den Einsatz unter MMS-Bedingungen bevorzugen, für den die Werkzeuge besonders geeignet sind.

Bei MMS-Einsatz empfehlen wir die Verwendung des kegeligen MMS-Schaftendes sowie der Hartner MMS-Einbauteile. Unser Außendienst berät Sie gerne.

Werkzeuge mit fett gesetzter Vorschubreihen-Nr. sind bevorzugt auszuwählen.

Bohrer-Ø mm	Vorschubreihen-Code								
	1	2	3	4	5	6	7	8	9
	f (mm/U)								
2,50	0,025	0,032	0,040	0,050	0,063	0,080	0,100	0,125	0,160
3,15	0,032	0,040	0,050	0,063	0,080	0,100	0,125	0,160	0,160
4,00	0,040	0,050	0,063	0,080	0,100	0,125	0,160	0,200	0,200
5,00	0,040	0,050	0,063	0,080	0,100	0,125	0,160	0,200	0,250
6,30	0,050	0,063	0,080	0,100	0,125	0,160	0,200	0,250	0,315
8,00	0,063	0,080	0,100	0,125	0,160	0,200	0,250	0,315	0,315
10,00	0,080	0,100	0,125	0,160	0,200	0,250	0,315	0,400	0,400
12,50	0,080	0,100	0,125	0,160	0,200	0,250	0,315	0,400	0,500
16,00	0,100	0,125	0,160	0,200	0,250	0,315	0,400	0,500	0,630
20,00	0,125	0,160	0,200	0,250	0,315	0,400	0,500	0,630	0,630
25,00	0,160	0,200	0,250	0,315	0,400	0,500	0,630	0,800	0,800

Kühlmittel:
 ● Emulsion
 ● Öl
 ○ Luft

Werkstoffgruppe	Werkstoffbeispiele, neue Bezeichnung (in Klammern alte Bezeichnung) Fettgedruckte Zahlen = Werkstoff-Nr. nach DIN EN	Zugfestigkeit MPa (N/mm ²)	Härte	Kühl- mittel
Allgemeine Baustähle	1.0035 S185(St33), 1.0486 P275N(StE285), 1.0345 P235GH(H1), 1.0425 P265GH(H2) 1.0050 E295 (St50-2), 1.0070 E360 (St70-2), 1.8937 P500NH (WStE500)	≤500 ≤1000		○
Automatenstähle	1.0718 11SMnPb30 (9SMnPb28), 1.0736 11SMn37 (9SMn36) 1.0727 46S20 (45S20), 1.0728 (60S20), 1.0757 46SPb20 (45SPb20)	≤850 ≤1000		○
Unlegierte Vergütungsstähle	1.0402 C22, 1.1178 C30E (Ck30) 1.0503 C45, 1.1191 C45E (Ck45) 1.0601 C60, 1.1221 C60E (Ck60)	≤700 ≤850 ≤1000		○
Legierte Vergütungsstähle	1.5131 50MnSi4, 1.7003 38Cr2, 1.7030 28Cr4 1.5710 36NiCr6, 1.7035 41Cr4, 1.7225 42CrMo4	≤1000 ≤1400		○
Unlegierte Einsatzstähle	1.0301 (C10), 1.1121 C10E (Ck10)	≤850		○
Legierte Einsatzstähle	1.7276 10CrMo11, 1.5125 11MnSi6 1.5752 15NiCr13, 1.7131 16MnCr5, 1.7264 20CrMo5	≤1000 ≤1400		●
Nitrierstähle	1.8504 34CrAl6 1.8519 31CrMoV9, 1.8550 34CrAlNi7	≤1000 ≤1400		●
Werkzeugstähle	1.1750 C75W, 1.2067 102Cr6, 1.2307 29CrMoV9 1.2080 X210Cr12, 1.2083 X42Cr13, 1.2419 105WCr6, 1.2767 X45NiCrMo4	≤850 ≤1400		○
Schnellarbeitsstähle	1.3243 S 6-5-2-5, 1.3343 S 6-5-2, 1.3344 S 6-5-3	≤1400		●
Federstähle	1.5026 55Si7, 1.7176 55Cr3, 1.8159 51CrV4 (51CrV4)		≤350 HB	●
Gehärtete Stähle	-		≤48 HRC ≤66 HRC	●
Rostfreie Stähle, geschwefelt austenitisch martensitisch	1.4005 X12CrS13, 1.4104 X14CrMoS17, 1.4105 X6CrMoS17, 1.4305 X8CrNiS18-9 1.4301 X5CrNi18-10 (V2A), 1.4541 X6CrNiTi18-10, 1.4571 X6CrNiMoTi 17-12-2 (V4A) 1.4057 X20CrNi172 (X17CrNi16-2), 1.4122 X39CrMo17-1, 1.4521 X2CrMoTi18-2	≤900 ≤1100 ≤1500		●
Gusseisen	0.6010 EN-GJL-100 (GG10), 0.6020 EN-GJL-200 (GG20) 0.6025 EN-GJL-250 (GG25), 0.6035 EN-GJL-350 (GG35)		≤240 HB ≤350 HB	○
Kugelgraphit- und Temperguss	0.7050 EN-GJS-500-7 (GGG50), 0.8035 EN-GJMw-350-4 (GTW35) 0.7070 EN-GJS-700-2 (GGG70), 0.8170 EN-GJMB-700-2 (GTS70)		≤240 HB ≤350 HB	○
Hartguss	-		≤350 HB	○
Neue Gusswerkstoffe GGV	EN-GJV250 (GGV25), EN-GJV350 (GGV35) EN-GJV400 (GGV40), EN-GJV500 (GGV50), SiMo 6		≤220 HB ≤300 HB	○
Neue Gusswerkstoffe ADI	EN-GJS-800-8 (ADI800), EN-GJS-1000-5 (ADI1000) EN-GJS-1200-2 (ADI1200), EN-GJS-1400-1 (ADI1400)	≤1000 ≤1400		○
Sonderlegierungen	Nimonic, Inconel, Monel, Hastelloy	≤2000		●
Titan und Titan-Legierungen	3.7024 Ti99,5, 3.7114 TiAl5Sn2,5, 3.7124 TiCu2 3.7154 TiAl6Zr5, 3.7165 TiAl6V4, 3.7184 TiAl4Mo4Sn2,5, - TiAl8Mo1V1	≤850 ≤1400		●
Aluminium und Al-Legierungen	3.0255 Al99,5, 3.2315 AlMgSi1, 3.3515 AlMg1	≤400		○
Al-Knetlegierungen	3.0615 AlMgSiPb, 3.1325 AlCuMg1, 3.3245 AlMg3Si, 3.4365 AlZnMgCu1,5	≤650		○
Al-Gusslegierungen ≤ 10 % Si	3.2131 G-AlSi5Cu1, 3.2153 G-AlSi7Cu3, 3.2573 G-AlSi9	≤600		○
≤ 24 % Si	3.2581 G-AlSi12, 3.2583 G-AlSi12Cu, - G-AlSi12CuNiMg	≤600		○
Magnesium-Legierungen	3.5200 MgMn2, 3.5812.05 G-MgAl8Zn1, 3.5612.05 G-MgAl6Zn1	≤400		○
Kupfer, niedriglegiert	2.0070 SE-Cu, 2.1020 CuSn6, 2.1096 G-CuSn5ZnPb	≤600		○
Messing, kurzspanend	2.0380 CuZn39Pb2, 2.0401 CuZn39Pb3, 2.0410 CuZn43Pb2	≤600		○
langspanend	2.0250 CuZn20, 2.0280 CuZn33, 2.0332 CuZn37Pb0,5	≤600		○
Bronzen, kurzspanend	2.1090 CuSn7ZnPb, 2.1170 CuPb5Sn5, 2.1176 CuPb10Sn 2.0790 CuNi18Zn19Pb	≤600 ≤850		○
Bronzen, langspanend	2.0916 CuAl5, 2.0960 CuAl9Mn, 2.1050 CuSn10 2.0980 CuAl11Ni, 2.1247 CuBe2	≤850 ≤1000		○
Kunststoffe, duroplastisch	Epoxidharz, Resopal, Pertinax, Moltopren	≤150		○
thermoplastisch	Plexiglas, Hostalen, Novodur, Makralon	≤100		○
aramidfaserverstärkt	Kevlar	≤1000		○
glas-/kohlefaserverstärkt	GFK/CFK	≤1000		○



Einsatzempfehlungen für TS-Drills

Artikel-Nr. HA
Artikel-Nr. zyl.

Norm/DIN

Schneidstoff

Oberfläche

Typ

Innenkühlung

Programm Seite

Werkzeuge mit fett gesetzter Vorschubreihen-Nr. sind bevorzugt auszuwählen.

Bohrer-Ø mm	Vorschubreihen-Code								
	1	2	3	4	5	6	7	8	9
	f (mm/U)								
2,50	0,025	0,032	0,040	0,050	0,063	0,080	0,100	0,125	0,160
3,15	0,032	0,040	0,050	0,063	0,080	0,100	0,125	0,160	0,160
4,00	0,040	0,050	0,063	0,080	0,100	0,125	0,160	0,200	0,200
5,00	0,040	0,050	0,063	0,080	0,100	0,125	0,160	0,200	0,250
6,30	0,050	0,063	0,080	0,100	0,125	0,160	0,200	0,250	0,315
8,00	0,063	0,080	0,100	0,125	0,160	0,200	0,250	0,315	0,315
10,00	0,080	0,100	0,125	0,160	0,200	0,250	0,315	0,400	0,400
12,50	0,080	0,100	0,125	0,160	0,200	0,250	0,315	0,400	0,500
16,00	0,100	0,125	0,160	0,200	0,250	0,315	0,400	0,500	0,630
20,00	0,125	0,160	0,200	0,250	0,315	0,400	0,500	0,630	0,630
25,00	0,160	0,200	0,250	0,315	0,400	0,500	0,630	0,800	0,800

Kühlmittel:

● Emulsion

● Öl

○ Luft

Bohrer-Ø mm	Vorschubreihen-Code für Artikel-Nr. 86400/86405/86401/86408/86412												
	56	57	58	59	60	61	62	63	64	65	66	67	68
	f (mm/U)												
0,50	0,006	0,012	0,018	0,022	0,030	0,035	0,040	0,045	0,050	0,050	0,055	0,060	0,060
0,80	0,008	0,016	0,024	0,032	0,040	0,050	0,060	0,070	0,080	0,080	0,080	0,090	0,090
1,00	0,012	0,022	0,032	0,042	0,060	0,070	0,080	0,090	0,100	0,100	0,110	0,110	0,120
1,50	0,021	0,036	0,051	0,066	0,090	0,100	0,120	0,130	0,150	0,150	0,160	0,170	0,180
2,00	0,032	0,052	0,072	0,092	0,120	0,140	0,160	0,180	0,200	0,210	0,220	0,230	0,240
2,50	0,045	0,070	0,095	0,120	0,150	0,170	0,200	0,220	0,250	0,260	0,270	0,280	0,300
3,00	0,060	0,090	0,120	0,150	0,180	0,210	0,240	0,270	0,300	0,310	0,330	0,340	0,360

Werkstoffgruppe	Werkstoffbeispiele, neue Bezeichnung (in Klammern alte Bezeichnung) Fettgedruckte Zahlen = Werkstoff-Nr. nach DIN EN	Zugfestigkeit MPa (N/mm ²)	Härte	Kühl- mittel
Allgemeine Baustähle	1.0035 S185(St33), 1.0486 P275N(StE285), 1.0345 P235GH(H1), 1.0425 P265GH(H2) 1.0050 E295 (St50-2), 1.0070 E360 (St70-2), 1.8937 P500NH (WStE500)	≤500 ≤1000		●
Automatenstähle	1.0718 11SMnPb30 (9SMnPb28), 1.0736 11SMn37 (9SMn36) 1.0727 46S20 (45S20), 1.0728 (60S20), 1.0757 46SPb20 (45SPb20)	≤850 ≤1000		●
Unlegierte Vergütungsstähle	1.0402 C22, 1.1178 C30E (Ck30) 1.0503 C45, 1.1191 C45E (Ck45) 1.0601 C60, 1.1221 C60E (Ck60)	≤700 ≤850 ≤1000		●
Legierte Vergütungsstähle	1.5131 50MnSi4, 1.7003 38Cr2, 1.7030 28Cr4 1.5710 36NiCr6, 1.7035 41Cr4, 1.7225 42CrMo4	≤1000 ≤1400		●
Unlegierte Einsatzstähle	1.0301 (C10), 1.1121 C10E (Ck10)	≤850		●
Legierte Einsatzstähle	1.7276 10CrMo11, 1.5125 11MnSi6 1.5752 15NiCr13, 1.7131 16MnCr5, 1.7264 20CrMo5	≤1000 ≤1400		●
Nitrierstähle	1.8504 34CrAl6 1.8519 31CrMoV9, 1.8550 34CrAlNi7	≤1000 ≤1400		●
Werkzeugstähle	1.1750 C75W, 1.2067 102Cr6, 1.2307 29CrMoV9 1.2080 X210Cr12, 1.2083 X42Cr13, 1.2419 105WCr6, 1.2767 X45NiCrMo4	≤850 ≤1400		●
Schnellarbeitsstähle	1.3243 S 6-5-2-5, 1.3343 S 6-5-2, 1.3344 S 6-5-3	≤1400		●
Federstähle	1.5026 55Si7, 1.7176 55Cr3, 1.8159 51CrV4 (51CrV4)		≤350 HB	●
Gehärtete Stähle	-		≤48 HRC ≤66 HRC	●
Rostfreie Stähle, geschwefelt austenitisch martensitisch	1.4005 X12CrS13, 1.4104 X14CrMoS17, 1.4105 X6CrMoS17, 1.4305 X8CrNiS18-9 1.4301 X5CrNi18-10 (V2A), 1.4541 X6CrNiTi18-10, 1.4571 X6CrNiMoTi 17-12-2 (V4A) 1.4057 X20CrNi172 (X17CrNi16-2), 1.4122 X39CrMo17-1, 1.4521 X2CrMoTi18-2	≤900 ≤1100 ≤1500		●
Gusseisen	0.6010 EN-GJL-100 (GG10), 0.6020 EN-GJL-200 (GG20) 0.6025 EN-GJL-250 (GG25), 0.6035 EN-GJL-350 (GG35)		≤240 HB ≤350 HB	●
Kugelgraphit- und Temperguss	0.7050 EN-GJS-500-7 (GGG50), 0.8035 EN-GJMw-350-4 (GTW35) 0.7070 EN-GJS-700-2 (GGG70), 0.8170 EN-GJMB-700-2 (GTS70)		≤240 HB ≤350 HB	●
Hartguss	-		≤350 HB	●
Neue Gusswerkstoffe GGV	EN-GJV250 (GGV25), EN-GJV350 (GGV35) EN-GJV400 (GGV40), EN-GJV500 (GGV50), SiMo 6		≤220 HB ≤300 HB	●
Neue Gusswerkstoffe ADI	EN-GJS-800-8 (ADI800), EN-GJS-1000-5 (ADI1000) EN-GJS-1200-2 (ADI1200), EN-GJS-1400-1 (ADI1400)	≤1000 ≤1400		●
Sonderlegierungen	Nimonic, Inconel, Monel, Hastelloy	≤2000		●
Titan und Titan-Legierungen	3.7024 Ti99,5, 3.7114 TiAl5Sn2,5, 3.7124 TiCu2 3.7154 TiAl6Zr5, 3.7165 TiAl6V4, 3.7184 TiAl4Mo4Sn2,5, - TiAl8Mo1V1	≤850 ≤1400		●
Aluminium und Al-Legierungen	3.0255 Al99,5, 3.2315 AlMgSi1, 3.3515 AlMg1	≤400		●
Al-Knetlegierungen	3.0615 AlMgSiPb, 3.1325 AlCuMg1, 3.3245 AlMg3Si, 3.4365 AlZnMgCu1,5	≤650		●
Al-Gusslegierungen ≤ 10 % Si	3.2131 G-AlSi5Cu1, 3.2153 G-AlSi7Cu3, 3.2573 G-AlSi9 3.2581 G-AlSi12, 3.2583 G-AlSi12Cu, - G-AlSi12CuNiMg	≤600 ≤600		●
Magnesium-Legierungen	3.5200 MgMn2, 3.5812.05 G-MgAl8Zn1, 3.5612.05 G-MgAl6Zn1	≤400		●
Kupfer, niedriglegiert	2.0070 SE-Cu, 2.1020 CuSn6, 2.1096 G-CuSn5ZnPb	≤600		●
Messing, kurzspanend	2.0380 CuZn39Pb2, 2.0401 CuZn39Pb3, 2.0410 CuZn43Pb2	≤600		●
Messing, langspanend	2.0250 CuZn20, 2.0280 CuZn33, 2.0332 CuZn37Pb0,5	≤600		●
Bronzen, kurzspanend	2.1090 CuSn7ZnPb, 2.1170 CuPb5Sn5, 2.1176 CuPb10Sn 2.0790 CuNi18Zn19Pb	≤600 ≤850		●
Bronzen, langspanend	2.0916 CuAl5, 2.0960 CuAl9Mn, 2.1050 CuSn10 2.0980 CuAl11Ni, 2.1247 CuBe2	≤850 ≤1000		●
Kunststoffe, duroplastisch	Epoxidharz, Resopal, Pertinax, Moltopren	≤150		○
thermoplastisch	Plexiglas, Hostalen, Novodur, Makralon	≤100		○
aramidfaserverstärkt	Kevlar	≤1000		○
glas-/kohlefaserverstärkt	GFK/CFK	≤1000		○



Einsatzempfehlungen für TS-Drills

Artikel-Nr. HA	HA
Artikel-Nr. HE	HE
Norm/DIN	
Schneidstoff	
Oberfläche	
Typ	
Innenkühlung	
Programm Seite	

Vorgehensweise:

- Anfräsen einer Fläche rechtwinklig zum Eintrittswinkel der Bohrbearbeitung (nur bei schrägen Flächen notwendig).
- Herstellen einer zylindrischen Pilotbohrung (Toleranz F9) mit einer Bohrtiefe von mindestens 1xD.
- Einfahren in Pilotbohrung mit ca. 300 U/min bei f = 500 mm/min.
- Einstellen des Kühlschmierstoffdruckes und der Drehzahl.
- Kontinuierliches Bohren auf volle Bohrtiefe ohne Entspanzyklus.
- Bei Durchgangsbohrungen mit schrägem Austritt die Vorschubgeschwindigkeit v_f ca. 1 mm vor dem Durchbrechen auf 40 % reduzieren.
- Nach Erreichen der Bohrtiefe Drehzahl und Kühlschmierstoff abschalten, Ausfahren im Eilgang.

Werkzeuge mit fett gesetzter Vorschubreihen-Nr. sind bevorzugt auszuwählen.

Bohrer-Ø mm	Vorschubreihen-Code								
	1	2	3	4	5	6	7	8	9
	f (mm/U)								
2,50	0,025	0,032	0,040	0,050	0,063	0,080	0,100	0,125	0,160
3,15	0,032	0,040	0,050	0,063	0,080	0,100	0,125	0,160	0,160
4,00	0,040	0,050	0,063	0,080	0,100	0,125	0,160	0,200	0,200
5,00	0,040	0,050	0,063	0,080	0,100	0,125	0,160	0,200	0,250
6,30	0,050	0,063	0,080	0,100	0,125	0,160	0,200	0,250	0,315
8,00	0,063	0,080	0,100	0,125	0,160	0,200	0,250	0,315	0,315
10,00	0,080	0,100	0,125	0,160	0,200	0,250	0,315	0,400	0,400
12,50	0,080	0,100	0,125	0,160	0,200	0,250	0,315	0,400	0,500
16,00	0,100	0,125	0,160	0,200	0,250	0,315	0,400	0,500	0,630

- Kühlmittel:
- Emulsion
 - Öl
 - Luft

Werkstoffgruppe	Werkstoffbeispiele, neue Bezeichnung (in Klammern alte Bezeichnung) Fettgedruckte Zahlen = Werkstoff-Nr. nach DIN EN	Zugfestigkeit MPa (N/mm ²)	Härte	Kühl- mittel
Allgemeine Baustähle	1.0035 S185(St33), 1.0486 P275N(StE285), 1.0345 P235GH(H1), 1.0425 P265GH(H2) 1.0050 E295 (St50-2), 1.0070 E360 (St70-2), 1.8937 P500NH (WStE500)	≤500 ≤1000		○
Automatenstähle	1.0718 11SMnPb30 (9SMnPb28), 1.0736 11SMn37 (9SMn36) 1.0727 46S20 (45S20), 1.0728 (60S20), 1.0757 46SPb20 (45SPb20)	≤850 ≤1000		○
Unlegierte Vergütungsstähle	1.0402 C22, 1.1178 C30E (Ck30) 1.0503 C45, 1.1191 C45E (Ck45) 1.0601 C60, 1.1221 C60E (Ck60)	≤700 ≤850 ≤1000		○
Legierte Vergütungsstähle	1.5131 50MnSi4, 1.7003 38Cr2, 1.7030 28Cr4 1.5710 36NiCr6, 1.7035 41Cr4, 1.7225 42CrMo4	≤1000 ≤1400		○
Unlegierte Einsatzstähle	1.0301 (C10), 1.1121 C10E (Ck10)	≤850		○
Legierte Einsatzstähle	1.7276 10CrMo11, 1.5125 11MnSi6 1.5752 15NiCr13, 1.7131 16MnCr5, 1.7264 20CrMo5	≤1000 ≤1400		●
Nitrierstähle	1.8504 34CrAl6 1.8519 31CrMoV9, 1.8550 34CrAlNi7	≤1000 ≤1400		●
Werkzeugstähle	1.1750 C75W, 1.2067 102Cr6, 1.2307 29CrMoV9 1.2080 X210Cr12, 1.2083 X42Cr13, 1.2419 105WCr6, 1.2767 X45NiCrMo4	≤850 ≤1400		○
Schnellarbeitsstähle	1.3243 S 6-5-2-5, 1.3343 S 6-5-2, 1.3344 S 6-5-3	≤1400		●
Federstähle	1.5026 55Si7, 1.7176 55Cr3, 1.8159 51CrV4 (51CrV4)		≤350 HB	●
Gehärtete Stähle	-		≤48 HRC ≤66 HRC	●
Rostfreie Stähle, geschwefelt austenitisch martensitisch	1.4005 X12CrS13, 1.4104 X14CrMoS17, 1.4105 X6CrMoS17, 1.4305 X8CrNiS18-9 1.4301 X5CrNi18-10 (V2A), 1.4541 X6CrNiTi18-10, 1.4571 X6CrNiMoTi 17-12-2 (V4A) 1.4057 X20CrNi172 (X17CrNi16-2), 1.4122 X39CrMo17-1, 1.4521 X2CrMoTi18-2	≤900 ≤1100 ≤1500		●
Gusseisen	0.6010 EN-GJL-100 (GG10), 0.6020 EN-GJL-200 (GG20) 0.6025 EN-GJL-250 (GG25), 0.6035 EN-GJL-350 (GG35)		≤240 HB ≤350 HB	○
Kugelgraphit- und Temperguss	0.7050 EN-GJS-500-7 (GGG50), 0.8035 EN-GJMw-350-4 (GTW35) 0.7070 EN-GJS-700-2 (GGG70), 0.8170 EN-GJMB-700-2 (GTS70)		≤240 HB ≤350 HB	○
Hartguss	-		≤350 HB	○
Neue Gusswerkstoffe GGV	EN-GJV250 (GGV25), EN-GJV350 (GGV35) EN-GJV400 (GGV40), EN-GJV500 (GGV50), SiMo 6		≤220 HB ≤300 HB	○
Neue Gusswerkstoffe ADI	EN-GJS-800-8 (ADI800), EN-GJS-1000-5 (ADI1000) EN-GJS-1200-2 (ADI1200), EN-GJS-1400-1 (ADI1400)	≤1000 ≤1400		○
Sonderlegierungen	Nimonic, Inconel, Monel, Hastelloy	≤2000		●
Titan und Titan-Legierungen	3.7024 Ti99,5, 3.7114 TiAl5Sn2,5, 3.7124 TiCu2 3.7154 TiAl6Zr5, 3.7165 TiAl6V4, 3.7184 TiAl4Mo4Sn2,5, - TiAl8Mo1V1	≤850 ≤1400		●
Aluminium und Al-Legierungen	3.0255 Al99,5, 3.2315 AlMgSi1, 3.3515 AlMg1	≤400		○
Al-Knetlegierungen	3.0615 AlMgSiPb, 3.1325 AlCuMg1, 3.3245 AlMg3Si, 3.4365 AlZnMgCu1,5	≤650		○
Al-Gusslegierungen ≤ 10 % Si ≤ 24 % Si	3.2131 G-AlSi5Cu1, 3.2153 G-AlSi7Cu3, 3.2573 G-AlSi9 3.2581 G-AlSi12, 3.2583 G-AlSi12Cu, - G-AlSi12CuNiMg	≤600 ≤600		○
Magnesium-Legierungen	3.5200 MgMn2, 3.5812.05 G-MgAl8Zn1, 3.5612.05 G-MgAl6Zn1	≤400		○
Kupfer, niedriglegiert	2.0070 SE-Cu, 2.1020 CuSn6, 2.1096 G-CuSn5ZnPb	≤600		○
Messing, kurzspanend	2.0380 CuZn39Pb2, 2.0401 CuZn39Pb3, 2.0410 CuZn43Pb2	≤600		○
Messing, langspanend	2.0250 CuZn20, 2.0280 CuZn33, 2.0332 CuZn37Pb0,5	≤600		○
Bronzen, kurzspanend	2.1090 CuSn7ZnPb, 2.1170 CuPb5Sn5, 2.1176 CuPb10Sn 2.0790 CuNi18Zn19Pb	≤600 ≤850		○
Bronzen, langspanend	2.0916 CuAl5, 2.0960 CuAl9Mn, 2.1050 CuSn10 2.0980 CuAl11Ni, 2.1247 CuBe2	≤850 ≤1000		○
Kunststoffe, duroplastisch	Epoxidharz, Resopal, Pertinax, Moltopren	≤150		○
thermoplastisch	Plexiglas, Hostalen, Novodur, Makralon	≤100		○
aramidfaserverstärkt	Kevlar	≤1000		○
glas-/kohlefaserverstärkt	GFK/CFK	≤1000		○

DAS HARTNER PROGRAMM



▼ FU 500 / FN 500



▼ TIEFLOCHBOHRER



▼ INOX-BOHRER



▼ KLEINSTBOHRER



▼ GEWINDEWERKZEUGE



▼ TS-DRILLS



▼ TF 100 MULTI-MILL



▼ VHM-FRÄSWERKZEUGE

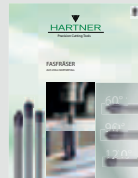

▼ FASFRÄSER



▼ MULTIPLEX



▼ MULTIPLEX HPC



▼ TM-WERKZEUG-AUSGABESYSTEME

HARTNER GMBH

Postfach 10 04 25 | 72425 Albstadt | Deutschland
 Telefon +49 74 31 125-0 | Fax +49 74 31 125-21 547

www.hartner.de

Eventuelle Druckfehler oder zwischenzeitlich eingetretene Änderungen berechtigen nicht zu Ansprüchen.
 Wir liefern ausschließlich zu unseren Liefer- und Zahlungsbedingungen. Diese können bei uns angefordert werden.

111 745/19003-11-05 | Gedruckt in Deutschland | 2019

HOMMEL
HERCULES

Hommel + Seitz GmbH

Hommel + Seitz Gesellschaft m.b.H. | Eduard-Kittenberger-Gasse 56, Obj. 8 | AT-1230 Wien
 Tel.: +43 1 865 48 28 0 | Fax: +43 1 865 48 22 | E-Mail: office@hommel-hercules.at

www.hommel-hercules.at

